

**HYBRID FLEX
INVERTER SYSTEM**

**Slim Duct /Compact Cassette
Compact Wall Mounted /
Wall Mounted**

INVERTER MULTI

SERVICE INSTRUCTION

Models

Indoor unit

Outdoor unit

ARU9RLF
ARU12RLF
ARU18RLF
ARU24RLF

AOU48RLXFZ

AUU9RLF
AUU12RLF
AUU18RLF

ASU7RLF
ASU9RLF
ASU12RLF
ASU18RLF
ASU24RLF



Refrigerant
R410A

CONTENTS

1. DESCRIPTION OF EACH CONTROL OPERATION

1-1. COOLING AND DRY OPERATION.....	01-01
1-2. HEATING OPERATION.....	01-02
1-3. AUTO CHANGEOVER OPERATION.....	01-03
1-4. INDOOR FAN CONTROL.....	01-05
1-5. LOUVER CONTROL.....	01-09
1-6. OUTDOOR FAN CONTROL.....	01-11
1-7. COMPRESSOR CONTROL.....	01-12
1-8. TIMER OPERATION CONTROL.....	01-14
1-9. ELECTRONIC EXPANSION VALVE CONTROL.....	01-17
1-10. TEST OPERATION CONTROL.....	01-18
1-11. 4-WAY VALVE EXTENSION SELECT.....	01-20
1-12. AUTO RESTART.....	01-20
1-13. MANUAL AUTO OPERATION.....	01-20
1-14. FORCED COOLING OPERATION	01-21
1-15. COMPRESSOR PREHEATING.....	01-21
1-16. MINIMUM HEAT OPERATIONEHEATING.....	01-21
1-17. DEFROST OPERATION CONTROL.....	01-22
1-18. OFF DEFROST OPERATION CONTROL.....	01-24
1-19. OIL RECOVERY OPERATION.....	01-25
1-20. FRESH AIR CONTROL(For AU / AR type).....	01-26
1-21. EXTERNAL ELECTRICAL HEATER CONTROL(For AR type).....	01-26
1-22. DRAIN PUMP OPERATION.....	01-27
1-23. ECONOMY OPERATION.....	01-28
1-24. ENERGY SAVING PEAK CUT FUNCTION.....	01-29
1-25. LOW NOISE MODE.....	01-29
1-26. VARIOUS PROTECTIONS.....	01-30

2. TROUBLE SHOOTING

2-1. SERVICE MAINTENANCE FOR HYBRID FLEX INVERTER SYSTEM.....	02-01
2-2. NORMAL OPERATION.....	02-05
2-3. ABNORMAL OPERATION.....	02-07
2-4. TROUBLE SHOOTING.....	02-16
2-5. SERVICE PARTS INFORMATION.....	02-65

3. DISASSEMBLY PARTS

3-1. DISASSEMBLY PROCESS FOR OUTDOOR UNIT.....	03-01
3-2. DISASSEMBLY PROCESS FOR BRANCH BOX.....	03-17

Hybrid Flex Inverter System

1 . DESCRIPTION OF EACH CONTROL OPERATION

1-1. COOLING AND DRY OPERATION

1-1-1. COOLING AND DRY CAPACITY CONTROL

A sensor (room temperature thermistor) built in the indoor unit body will usually perceive difference or variation between a set temperature and present room temperature, and controls the operation speed of the compressor.

The outdoor unit operates according to the highest request capacity of indoor unit to meet the demand capacity of all the indoor units.

The capacity control of the low request capacity indoor unit is controlled by Branch box EEV.

(Table 1 : Compressor speed range)

	Minimum	Maximum
AOU48RLXFZ	18rps	90rps

< Target high pressure control >

The outdoor fan speed is controlled to keep the high pressure to the constant range for stabilizing the distribution performance.

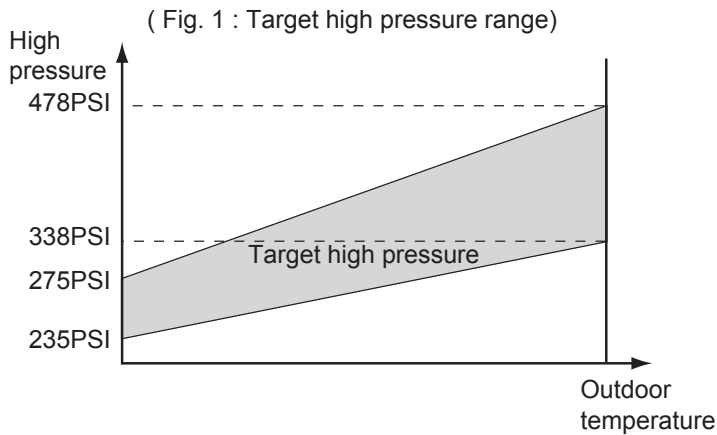

< Target low pressure control >

When the start-up control finished, the outdoor unit starts the target low pressure control. The outdoor unit selects the target low pressure within the following range, it is decided by the highest request capacity from indoor units.

(Fig. 2 : Target low pressure range)

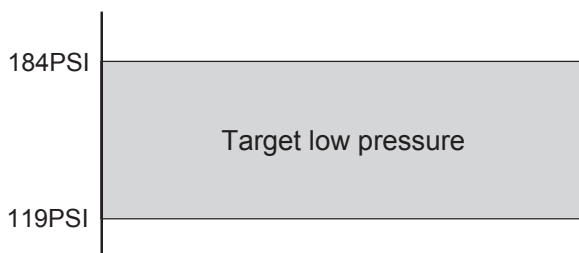

1-2. HEATING OPERATION

1-2-1. HEATING CAPACITY CONTROL

A sensor (room temperature thermistor) built in the indoor unit body will usually perceive difference or variation between a set temperature and present room temperature, and controls the operation speed of the compressor.

The outdoor unit operates according to the highest request capacity of indoor unit to meet the demand capacity of all the indoor units.

The capacity control of the low request capacity indoor unit is controlled by Branch box EEV.

(Table 2 : Compressor speed range)

	Minimum	Maximum
AOU48RLXFZ	18rps	96rps

< Target high pressure control >

When the start-up control finished, the outdoor unit starts the target high pressure control. The outdoor unit selects the target high pressure within the following range, it is decided by the highest request capacity from indoor units.

(Fig. 3 : Target high pressure range for NORMAL HEATING OPERATION)

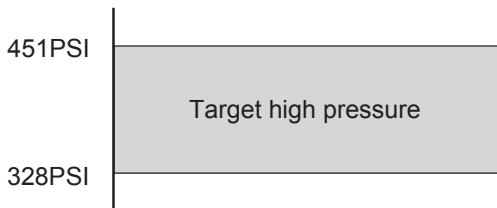

(Fig. 4 : Target high pressure range for MIN. HEAT OPERATION)

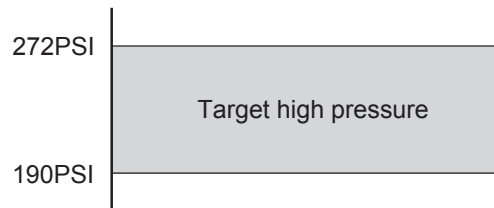

< Target low pressure control >

The outdoor fan speed is controlled to keep the low pressure to the constant range for the following reasons.

1. Frost prevention
2. Low pressure over rise prevention

(Fig. 5 : Target low pressure range)

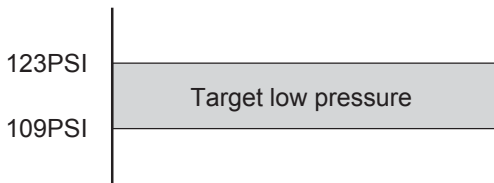

1-3. AUTO CHANGEOVER OPERATION

When the air conditioner is set to the Auto mode by remote controller, operation starts in the optimum mode from among the Heating, Cooling, Dry and Monitoring mode. During operation, the optimum mode is automatically switched in accordance with temperature changes. The temperature can be set between 64°F(18°C) and 88°F(30°C) in 2°F(1°C) steps.

- ① When operation starts, indoor fan and outdoor fan are operated for around 3 minutes. Room temperature and outdoor temperature are sensed, and the operation mode is selected in accordance with the table below. <Monitoring mode>

(Table 3 : Operation mode selection table)

Room temperature (TR)	Operation mode
$TR > Ts + 4^{\circ}\text{F}(+2^{\circ}\text{C})$	Cooling (Automatic dry)
$Ts + 4^{\circ}\text{F}(+2^{\circ}\text{C}) \geq TR \geq Ts - 4^{\circ}\text{F}(-2^{\circ}\text{C})$	*Middle zone
$TR < Ts - 4^{\circ}\text{F}(-2^{\circ}\text{C})$	Heating

TR : Room temperature
Ts : Setting temperature

*If it's Middle zone, operation mode of indoor unit is selected as below.

- (1). Same operation mode is selected as outdoor unit.
If outdoor unit is operating in Cooling, Dry, and Heating mode, indoor unit will be operated by the same operation mode.
- (2). Selected by the outdoor temperature.
If outdoor unit is operating in other than Cooling, Dry, and Heating mode, indoor unit will be operated according to the outdoor temperature as below.

(Fig. 6 : Outdoor temperature zone selection)

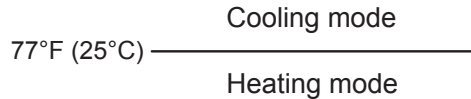

- ② When Cooling or Dry mode was selected at ① and air flow mode is Auto, the air conditioner operates as follow.
- The same operation as COOLING OPERATION AND DRY OPERATION of page 01-01 is performed.
 - When the room temperature has remained at set temperature -3°F(-1.5°C), operation is automatically switched to Dry mode.
 - If the room temperature reaches set temperature +4°F(+2°C) during Dry mode, operation returns to Cooling.

(Fig.7 : Auto changeover : Cooling - Dry)

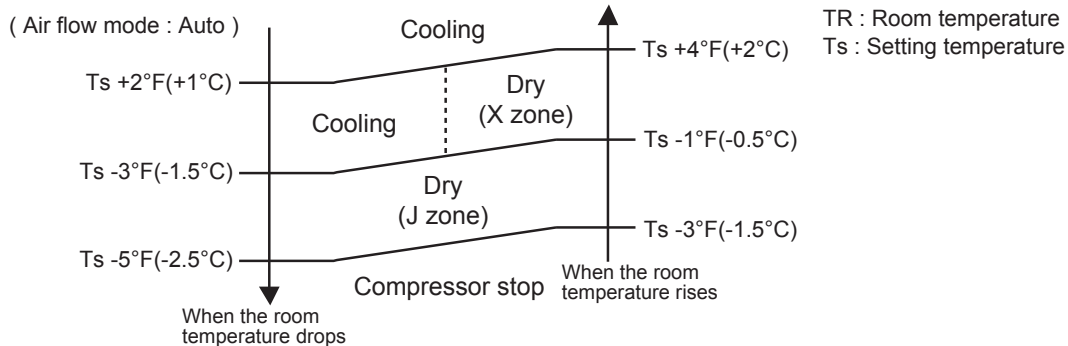

- ③ When Heating was selected at ①, the same operation as HEATING OPERATION of page 01-02 is performed.
- ④ When the compressor was stopped for 6 consecutive minutes by the temperature control function after the Cooling(Auto:Dry) or Heating mode was selected at ① above, operation is switched to Monitoring and the operation mode is selected again.

■ AUTO CHANGEOVER operation flow chart

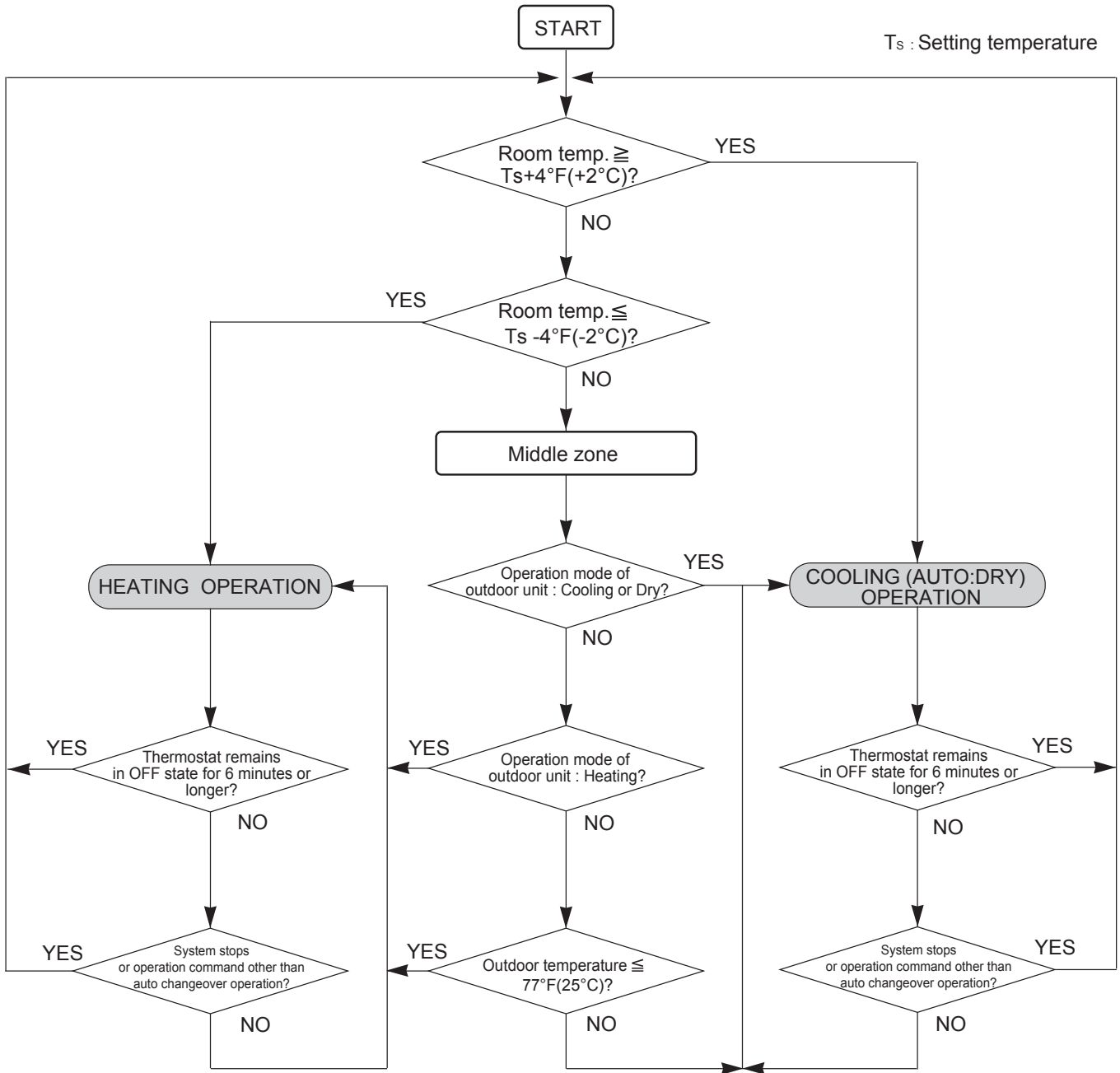

1-4. INDOOR FAN CONTROL

1. Fan speed

(Table 4 : Indoor fan speed table)

ASU7RLF

Operation mode	Air flow mode	Fan Speed
Heating	Hi	1050
	Me+	1000
	Me	950
	Lo	850
	Quiet	720
	Cool Air Prevention	600
	S-Lo	480
Cooling / Fan	Hi	1050
	Me	950
	Lo	850
	Quiet	710
	*Soft Quiet	600
Dry	Auto	X, J zone:710

ASU9RLF

Operation mode	Air flow mode	Fan Speed
Heating	Hi	1100
	Me+	1040
	Me	980
	Lo	850
	Quiet	720
	Cool Air Prevention	600
	S-Lo	480
Cooling / Fan	Hi	1100
	Me	980
	Lo	850
	Quiet	710
	*Soft Quiet	600
Dry	Auto	X, J zone:710

ASU12RLF

Operation mode	Air flow mode	Fan Speed
Heating	Hi	1200
	Me+	1130
	Me	1050
	Lo	910
	Quiet	720
	Cool Air Prevention	600
	S-Lo	480
Cooling / Fan	Hi	1200
	Me	1050
	Lo	880
	Quiet	710
	*Soft Quiet	600
Dry	Auto	X, J zone:710

ASU18RLF

Operation mode	Air flow mode	Fan Speed
Heating	Hi	1260
	Me+	1120
	Me	1020
	Lo	900
	Quiet	790
	Cool Air Prevention	680
	S-Lo	480
Cooling / Fan	Hi	1260
	Me	1020
	Lo	900
	Quiet	770
	*Soft Quiet	680
Dry	Auto	X, J zone:770

ASU24RLF

Operation mode	Air flow mode	Fan Speed
Heating	Hi	1430
	Me+	1320
	Me	1220
	Lo	1020
	Quiet	900
	Cool Air Prevention	720
	S-Lo	480
Cooling / Fan	Hi	1480
	Me	1220
	Lo	1020
	Quiet	900
	*Soft Quiet	720
Dry	Auto	X, J zone:900

AUU9RLF

Operation mode	Air flow mode	Fan Speed
Heating	Hi	590
	Me+	570
	Me	540
	Lo	490
	Quiet	440
	Cool Air Prevention	400
	S-Lo	300
Cooling / Fan	Hi	590
	Me	540
	Lo	490
	Quiet	440
	*Soft Quiet	400
Dry	Auto	X, J zone:440

*Note, during Economy operation and operation mode is Fan, air flow is 1 step downs.
(Hi > Me, Me > Lo, Quiet > Soft Quiet)

AUU12RLF

Operation mode	Air flow mode	Fan Speed
Heating	Hi	650
	Me+	620
	Me	580
	Lo	520
	Quiet	460
	Cool Air Prevention	400
	S-Lo	300
Cooling / Fan	Hi	660
	Me	580
	Lo	520
	Quiet	460
	Soft Quiet	400
	Auto	X, J zone:460

AUU18RLF

Operation mode	Air flow mode	Fan Speed
Heating	Hi	840
	Me+	800
	Me	750
	Lo	650
	Quiet	500
	Cool Air Prevention	400
	S-Lo	300
	Cooling / Fan	Hi
Me		660
Lo		570
Quiet		460
Soft Quiet		400
Auto		X, J zone:460

ARU9RLF (Static pressure:25Pa)

Operation mode	Air flow mode	Fan Speed
Heating	Hi	1260
	Me	1160
	Lo	1060
	Quiet	960
	S-Lo	500
	Cooling / Fan	Hi
Me		1160
Lo		1060
Quiet		960
Soft Quiet		500
Auto		X, J zone:960

ARU12RLF (Static pressure:25Pa)

Operation mode	Air flow mode	Fan Speed
Heating	Hi	1340
	Me	1240
	Lo	1140
	Quiet	1030
	S-Lo	500
	Cooling / Fan	Hi
Me		1240
Lo		1140
Quiet		1030
Soft Quiet		500
Auto		X, J zone:1030

ARU18RLF (Static pressure:25Pa)

Operation mode	Air flow mode	Fan Speed
Heating	Hi	1380
	Me	1300
	Lo	1220
	Quiet	1140
	S-Lo	600
	Cooling / Fan	Hi
Me		1300
Lo		1220
Quiet		1140
Soft Quiet		600
Auto		X, J zone:1140

ARU24RLF (Static pressure:25Pa)

Operation mode	Air flow mode	Fan Speed
Heating	Hi	1460
	Me	1360
	Lo	1260
	Quiet	1180
	S-Lo	600
	Cooling / Fan	Hi
Me		1360
Lo		1260
Quiet		1180
Soft Quiet		600
Auto		X, J zone:1180

2. FAN OPERATION

The airflow can be switched in 5 steps such as Auto, Quiet, Lo, Me, Hi, while the indoor fan only runs.

When Fan mode is set at (Auto), it operates on (Me) Fan Speed. < All models >

3. COOLING OPERATION (Auto : Cooling)

Switch the airflow [Auto], and the indoor fan motor will run according to a room temperature, as shown in Fig. 8.

On the other hand, if switched in [Hi] ~ [Quiet], the indoor motor will run at a constant airflow of [Cooling] operation modes Quiet, Lo, Me, Hi.

(Fig.8 : Airflow change - over)

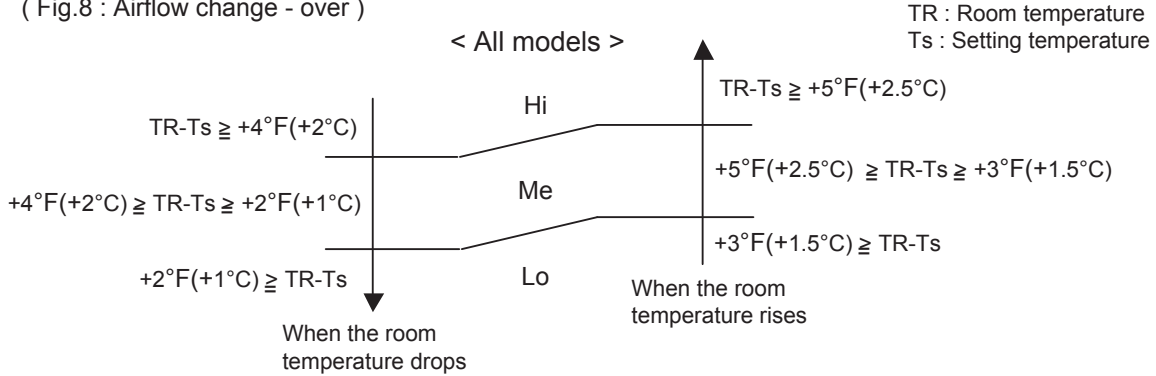

4. DRY OPERATION (Auto : Dry)

During the dry operation, the fan speed setting can not be changed, it operates automatically as shown in Fig. 8

Room temperature variation which the room temperature sensor of the indoor unit body has detected.

(Fig. 9 : Indoor fan control)

< All models >

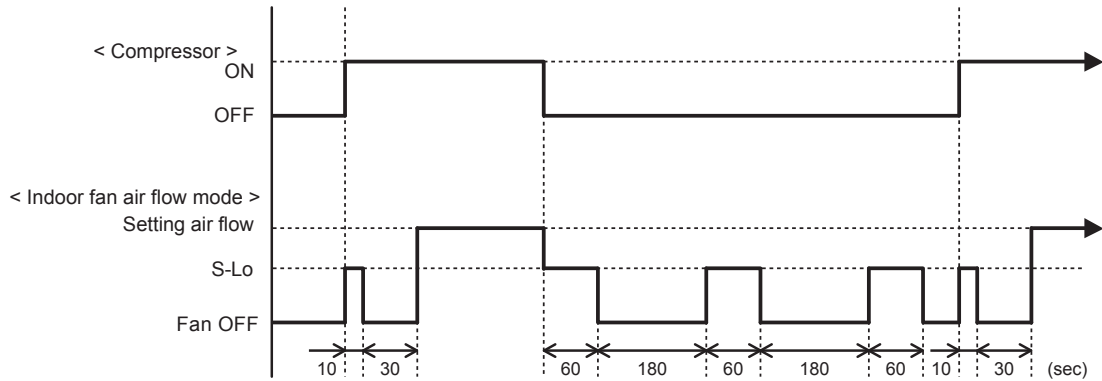

5. HEATING OPERATION

Switch the airflow [Auto], and the indoor fan motor will run according to a room temperature, as shown in Fig 10.

On the other hand, if switched in [Hi] ~ [Quiet], the indoor motor will run at a constant airflow of [Heat] operation modes Quiet, Lo, Me, Hi, as shown in Table 4.

(Fig.10 : Airflow change - over (Heating : Auto))

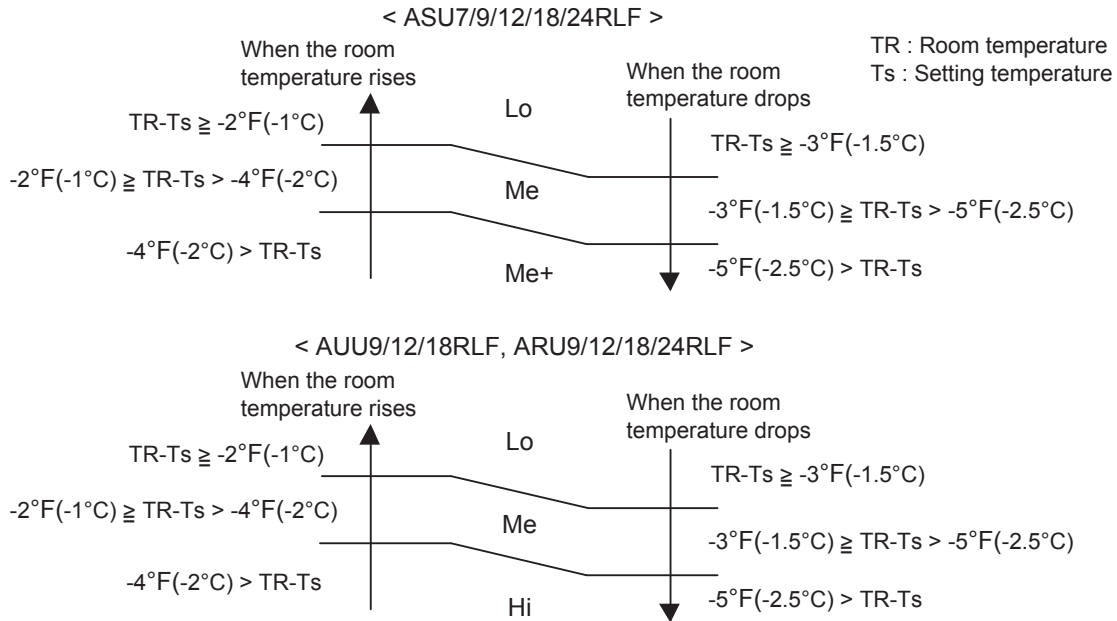

6. COOL AIR PREVENTION CONTROL (For Heating and Min. Heat operation)

The maximum value of the indoor fan speed is set as shown in Fig 10, based on the detected temperature by the indoor heat exchanger sensor in heating mode.

Field setting is necessary at AR and AU type as "Cool air prevention : effective"

(Fig.11 : Airflow change - over for cool air prevention)

During NORMAL HEATING OPERATION

< ASU7/9/12/18/24RLF, AUU9/12/18RLF >

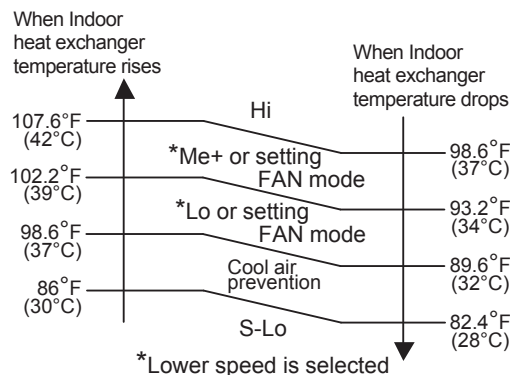

< ARU9/12/18/24RLF >

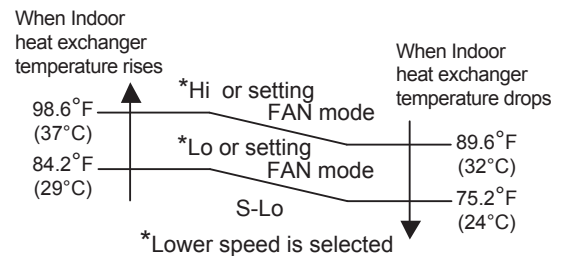

During MIN. HEAT OPERATION

< ASU7/9/12/18/24RLF, AUU9/12/18RLF >

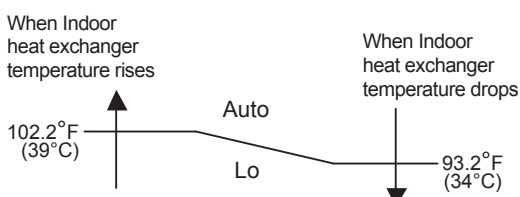

< ARU9/12/18/24RLF >

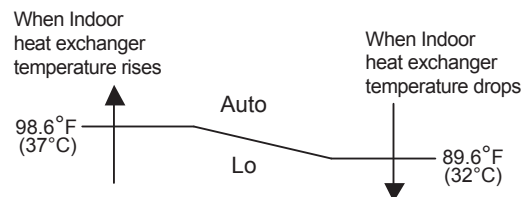

1-5. LOUVER CONTROL

For Compact Wall Mounted Type, Wall Mounted Type < ASU7/ 9/ 12/ 18/ 24RLF >

1. VERTICAL LOUVER CONTROL

(Function Range)

Each time the button is pressed, the air direction range will change as follow:

① ⇄ ② ⇄ ③ ⇄ ④ ⇄ ⑤ ⇄ ⑥

(Table9 : Recommended Operation Range)

Cooling / Heating / Dry mode / Fan mode

① ⇄ ② ⇄ ③ ⇄ ④ ⇄ ⑤ ⇄ ⑥

<Compact Wall Mounted Type>

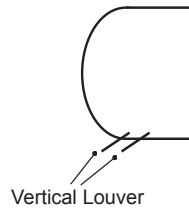

Vertical Louver

<Wall Mounted Type>

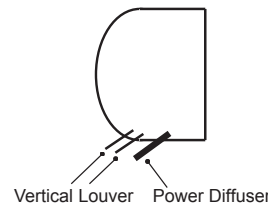

Vertical Louver Power Diffuser

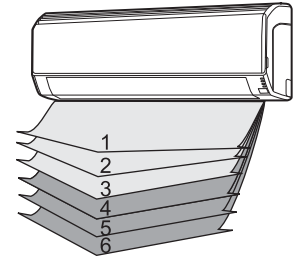

(Fig.12 : Vertical Air Direction Range)

Use the air direction adjustments within the ranges shown above.

- The vertical airflow direction is set automatically as shown, in accordance with the type of operation selected.

Cooling / Dry mode : Horizontal flow ①

Heating mode : Downward flow ASU7/9/12:⑥, ASU18/24:⑤

- When the temperature of the air being blown out is low at the start of heating operation or during defrosting, the airflow direction temporarily becomes ① to prevent cold air being blown onto the body.
- During use of the Cooling and Dry modes, do not set the Air Flow Direction Louver in the Heating range (④~⑥) for long period of time, since water vapor may condense near the outlet louvers and drop of water may drip from the air conditioner. During the Cooling and Dry modes, if the Air Flow Direction Louvers are left in the heating range for around 30 minutes, they will automatically return to position ③.

2. HORIZONTAL LOUVER CONTROL (For ASU18/ 24RLF)

(Function Range)

Each time the button is pressed, the air direction range will change as follows. ASU7/9/12RLF changes by manual.

(Fig.13 : Horizontal Air Direction Range)

Cooling / Heating / Dry mode / Fan mode

① ⇄ ② ⇄ ③ ⇄ ④ ⇄ ⑤

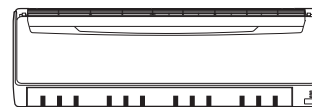

Horizontal Louver

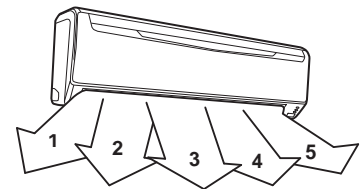

3. SWING OPERATION

Vertical Airflow Swing Operation

When the swing signal is received from the remote controller, the vertical louver starts to swing.

(Swinging Range)

Cooling mode / Dry mode / Fan mode(①~③) : ① ⇄ ④

Heating mode / Fan mode(④~⑥) : ASU7/9/12 [④ ⇄ ⑥], ASU18/24 [③ ⇄ ⑥]

- When the indoor fan is S-Lo or Stop mode, the swing operation is interrupted and it stops at either upper end or bottom end.

Horizontal Airflow Swing Operation (For ASU18/24RLF)

When the swing signal is received from the remote controller, the horizontal louver starts to swing.

(Swinging Range)

All mode : ① ⇄ ⑤

- When the indoor fan is S-Lo or Stop mode, the swing operation is interrupted and it stops at either upper end or bottom end.

Vertical and Horizontal Airflow Swing Operation

- When the horizontal swing signal is input from remote control, the combination of the vertical and horizontal swing operation is performed.

※ Power Diffuser doesn't swing in any swing operation.

For Compact Cassette Type < AUU9/ 12/ 18RLF >

1. VERTICAL LOUVER CONTROL

(Function Range)

Each time the button is pressed, the air direction range will change as follows:

①↔②↔③↔④

(Operation Range)

During COOLING / HEATING / DRY / FAN mode : ①—②—③—④

(Fig.14 : Air Direction Range)

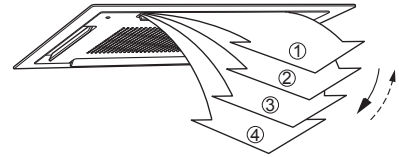

Use the air direction adjustments within the ranges shown above.

- The vertical airflow direction is set automatically as shown, in accordance with the type of operation selected.
 - COOLING / DRY / FAN mode : Horizontal flow ①
 - HEATING mode : Downward flow ④
- During AUTO mode operation, for the first minute after start-up, air-flow will be horizontal ① ; the air direction cannot be adjusted during this period.

2. SWING OPERATION

When the swing signal is received from the remote controller, the vertical louver starts to swing. The range of swing depends on the set airflow direction.

The type of operation	Range of swing
COOLING / HEATING / DRY / FAN	① to ④

- When the indoor fan is either at S-Lo or Stop mode, the swinging operation is interrupted and the louver stops at the memorized position.
(Stop mode means Operation stop.)

1-6. OUTDOOR FAN CONTROL

1. Fan speed table

Table 5 shows the fan speed of the outdoor unit.

(Table 5 : Outdoor fan speed table)

AOU48RLXFZ [rpm]

Fan step	Fan speed
0	0
1	250
2	290
3	340
4	390
5	460
6	580
7	690
8	800
9	890
10	910
11	950

2. Limit of fan speed range

Fig.15 shows the limit of fan speed range changes by outdoor temperature.

(Fig.15 : Limit of fan speed range)

< Cooling and Dry mode >		< Heating mode >	
Outdoor temperature	890rpm	Outdoor temperature	460 ~ 910rpm
86°F(30°C)	_____	41°F(5°C)	_____
	580 ~ 890rpm		460 ~ 950rpm
68°F(20°C)	_____		
	250 ~ 890rpm		
50°F(10°C)	_____		
	0 ~ 890rpm		

3. Initial fan speed control

Initial fan speed is decided by outdoor temperature.

(Fig.16 : Initial fan speed range)

< Cooling and Dry mode >		< Heating mode >	
Outdoor temperature	690rpm		Fixed at 690rpm
50°F(10°C)	_____		
	390rpm		

* If the fan motor is running over than 400rpm, it start up process is stopped in all conditions. [Prevent the big wind operation]

* When the fan motor is stopped, it can not restart for 10 seconds.

* Even if during EEV initialization, outdoor unit fan starts.

1-7. COMPRESSOR CONTROL

1. OPERATION SPEED RANGE

The operation speed of the compressor is different based on the operation mode as shown in the Table 6.

(Table 6 : Compressor operation speed range)

	Dry / Cooling		Heating	
	Minimum	Maximum	Minimum	Maximum
AOU48RLXFZ	18rps	90rps	18rps	96rps

2. OPERATION SPEED CONTROL AT START-UP

The compressor speed soon after the start-up is controlled for

2-1 Cooling and Dry start-up process

< Pattern 1 >

If it does not meet the condition of pattern 2, the compressor will start at pattern 1.

(Fig.17 : Pattern 1)

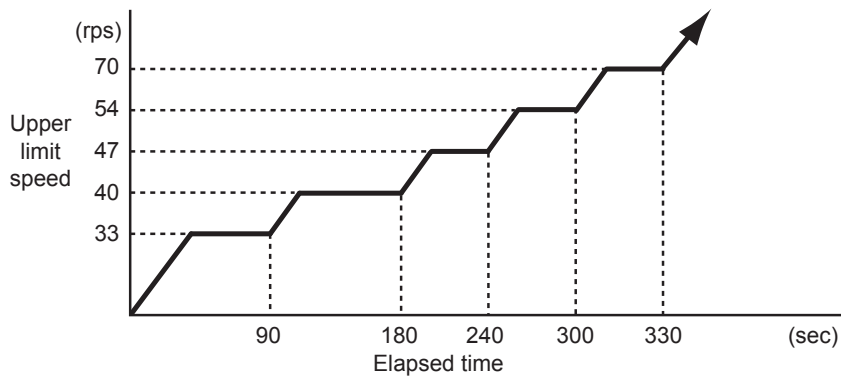

< Pattern 2 >

If it meets one of the following conditions, the compressor will start at pattern 2.

Condition	Compressor control before operation stops	Stop time of compressor	Compressor temperature
1	Target pressure control	Below 3 hours	Over 32°C
2	Start-up process 2		
3	Oil recovery / Defrost		

(Fig.18 : Pattern 2)

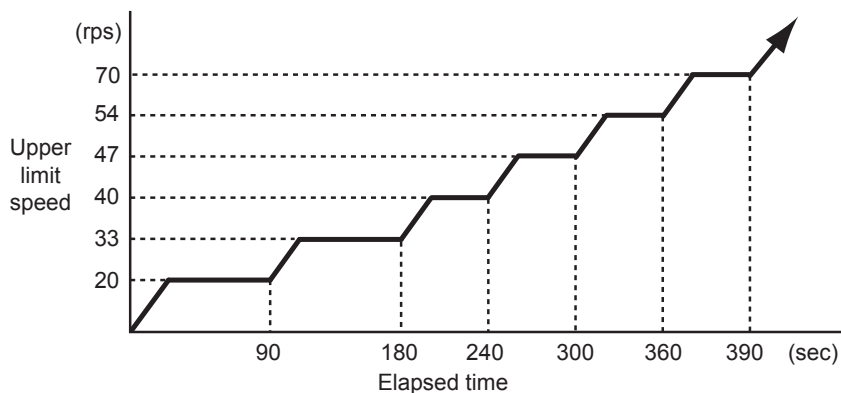

2-2 Heating start-up process

< Pattern 1 >

If it does not meet the condition of pattern 2, the compressor will start at pattern 1.

(Fig.19 : Heating start-up pattern 1)

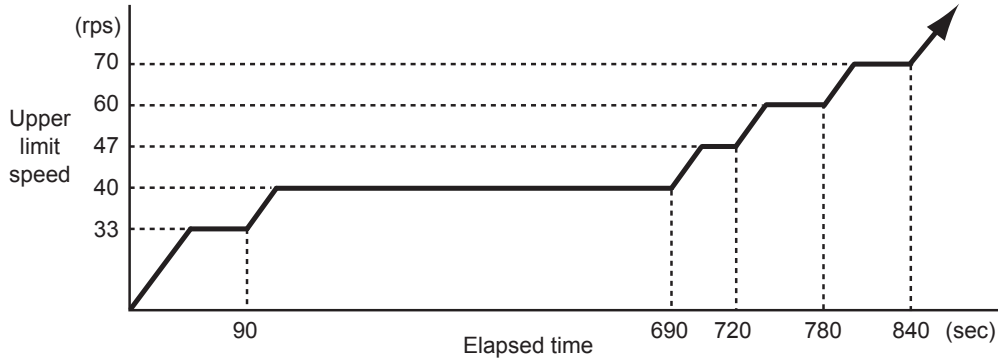

< Pattern 2 >

If it meets one of the following conditions, the compressor will start at pattern 2.

Condition	Compressor control before operation stops	Stop time of compressor	Compressor temperature
1	Target pressure control	Below 3 hours	Over 89.6°F (32°C)
2	Start-up process 2		
3	Oil recovery / Defrost		

(Fig.20 : Heating start-up pattern 2)

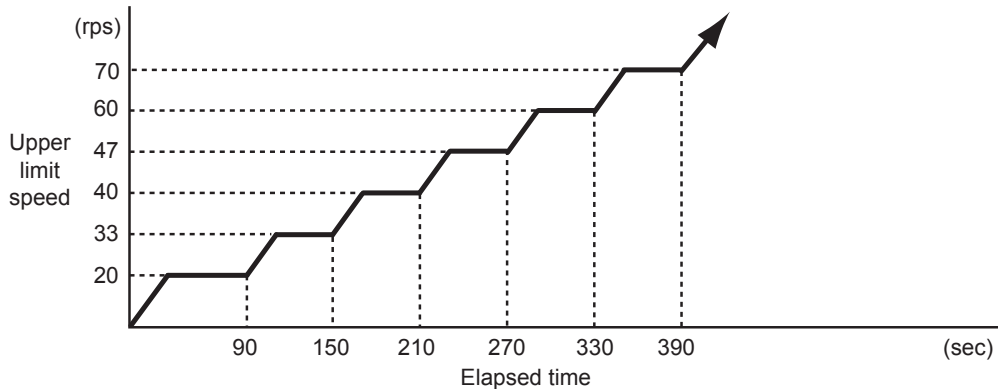

3. LIMIT OF THE COMPRESSOR SPEED RANGE

The compressor speed range is limited by outdoor temperature as shown in Fig.21

(Fig.21 : Limit of the compressor speed range)

< Cooling and Dry mode >		< Heating mode >	
Outdoor temperature	21 ~ 90rps	Outdoor temperature	21 ~ 90rps
104°F(40°C)	18 ~ 90rps	53.6°F(12°C)	18 ~ 96rps
50°F(10°C)	25 ~ 90rps	41°F(5°C)	23 ~ 96rps
23°F(-5°C)	27 ~ 90rps	5°F(-15°C)	25 ~ 96rps
14°F(-10°C)			

* 0rps

*Protection stop for low outdoor temperature. It will be released when outdoor temperature becomes over than 14°F(-10°C)

1-8. TIMER OPEARTION CONTROL

1-8-1 WIRELESS REMOTE CONTROLLER

The table 7 shows the available timer setting based on the product model.

(Table 7 : Timer setting)

ON TIMER / OFF TIMER	PROGRAM TIMER	SLEEP TIMER
○	○	○

1. ON / OFF TIMER

- OFF timer : When the clock reaches the set time, the air conditioner will be turned off.

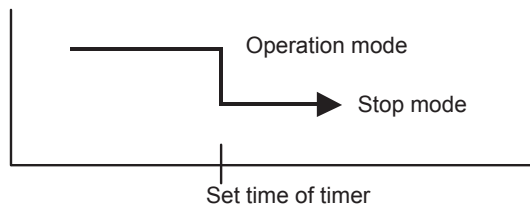

- ON timer : When the clock reaches the set time, the air conditioner will be turned on.

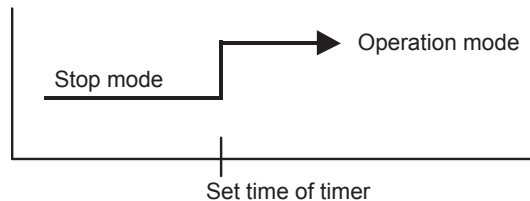

2. PROGRAM TIMER

- The program timer allows the OFF timer and ON timer to be used in combination one time.

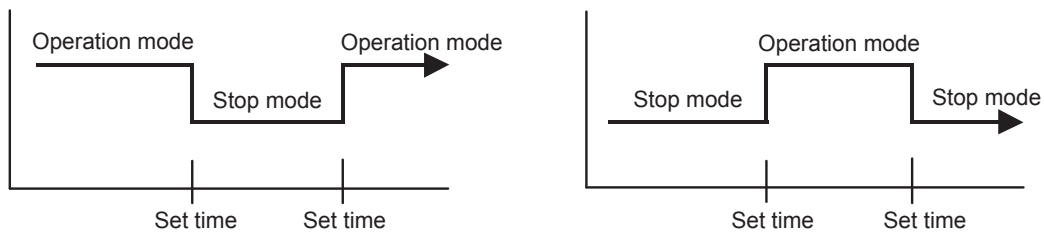

- Operation will start from the timer setting (either OFF timer or ON timer) whichever is closest to the clock's current timer setting.
The order of operations is indicated by the arrow in the remote control unit's display.
- SLEEP timer operation cannot be combined with ON timer operation.

3. SLEEP TIMER

If the sleep is set, the room temperature is monitored and the operation is stopped automatically. If the operation mode or the set temperature is change after the sleep timer is set, the operation is continued according to the changed setting of the sleep timer from that time ON.

In the cooling operation mode

When the sleep timer is set, the setting temperature is increased $2^{\circ}\text{F}(1^{\circ}\text{C})$.

It increases the setting temperature another $2^{\circ}\text{F}(1^{\circ}\text{C})$ after 1 hour.

After that, the setting temperature is not changed and the operation is stopped at the time of timer setting.

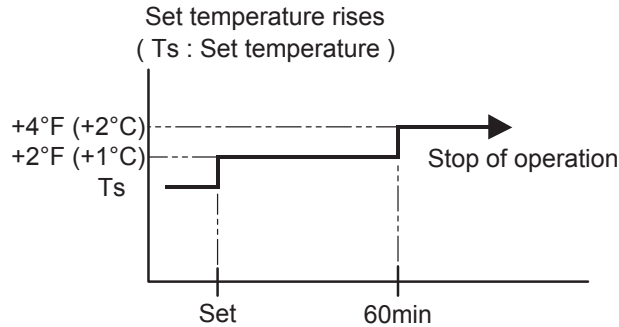

In the heating operation mode

When the sleep timer is set, the setting temperature is decreased $2^{\circ}\text{F}(1^{\circ}\text{C})$.

It decreases the setting temperature another $2^{\circ}\text{F}(1^{\circ}\text{C})$ every 30 minutes.

Upon lowering 4deg C, the setting temperature is not changed and the operation stops at the time of timer setting.

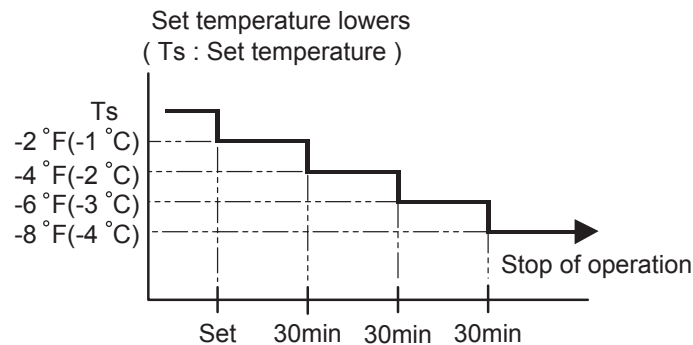

1-8-2 WIRED REMOTE CONTROLLER

The Table 8 shows the available timer setting based on the product model.

(Table 8 : Timer setting)

ON TIMER / OFF TIMER	WEEKLY TIMER	TEMPERATURE SET BACK TIMER
○	○	○

1. ON TIMER / OFF TIMER

Same to 1-8-1 **ON / OFF TIMER** and shown in those.

2. WEEKLY TIMER

This timer function can set operation times of the each day of the week.

All days can be set together, the weekly timer can be used to repeat the timer setting for all of the days.

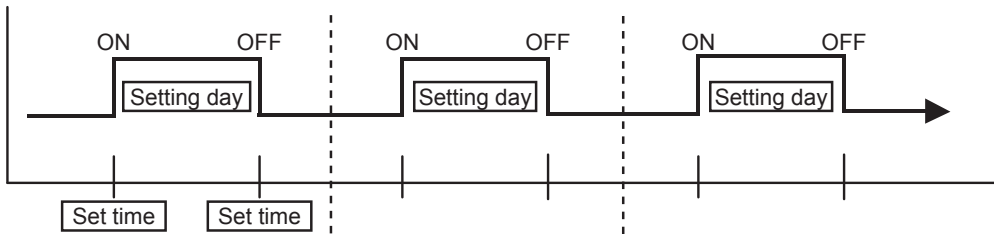

3. TEMPERATURE SET BACK TIMER

This timer function can change setting temperature of setting operation times of the each day of the week.

This can be together with other timer setting.

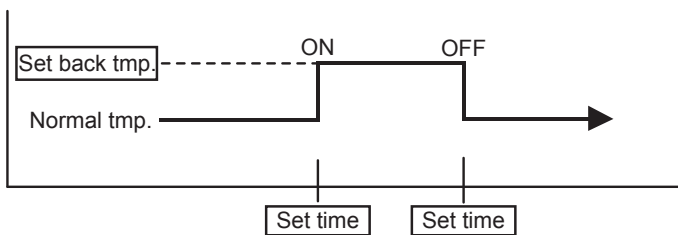

1-9. ELECTRONIC EXPANSION VALVE CONTROL

The most proper opening of the electronic expansion valve is calculated and controlled under the present operating condition based on the following values.

The compressor frequency, the temperatures detected by the discharge temperature sensor, the indoor heat exchanger sensor, the outdoor heat exchanger sensor, and the outdoor temperature sensor.

1. Pulse range

(Table 9 : Pulse range of outdoor unit EEV)

Outdoor unit	Operation mode	Pulse range
Main EEV	Dry / Cooling Heating	40 ~ 480
Subcool EEV		35 ~ 480

During heating operation, lower limit is 0 pulse.

(Table 10 : Pulse range of branch box EEV)

Branch box	Operation mode	Pulse range
Main EEV	Dry / Cooling Heating	32 ~ 480
Bypass EEV		0 ~ 480

There is a case that EEV is full close at 32 ± 10 pulse.

2. Initialization

Initialization (Input of 528 pulses toward closing direction) is operated under the following conditions. It apply to all of EEV.

< Initialization conditions >

- Power-on.
- 4 hours has passed from the last initialization, and when the compressor starts.
- If 12 hours has passed from the last initialization, the compressor is compulsorily stopped.
- 3 minutes has passed from the protection stop of outdoor unit.

1-10. TEST OPERATION CONTROL

< Pre-test run check items >

Before the test run, refer to the figure and check the following items.

1. Is check run performed? Test run doesn't operate if check run is not performed.
After checking that the above items are all in order, refer to Test run method "to test run the unit.
If there are problems, adjust immediately and recheck.

< Test run method >

Be sure to configure test run settings only when the outdoor unit has stopped operating.

- Depending on the communication status between the indoor and outdoor units, it may take several minutes for the system to start operating after settings for the test run are complete.
- After the test run settings are complete, all the outdoor units and the connected indoor units will start operating. Room temperature control will not activate during test run (continuous operation).
- Test run set with the outdoor unit doesn't stop automatically. Be sure to stop the operation according to the operation method.
- All indoor units will operate when test run is performed from the outdoor unit. At this time, the remote controller of the indoor unit is unavailable.
- Operation mode cannot be changed during the test run. To change the operation mode, please stop the test run first, and then perform the test run again. At this time, the compressor cannot be restarted for three minutes after it stops in order to protect the indoor unit. Please restart it after three minutes.

▪ With Wired Remote Controller

Under the condition where the air conditioner stops, press the MODE button and the FAN button simultaneously for 2 seconds or more, and the test operation control mode will appear.

During test running, "  " will display on the remote controller display.
Set the test operation mode, and the compressor will continue to run regardless of whatever the room temperature sensor detects.

▪ With Wireless Remote Controller

Under the condition where the air conditioner runs, press the TEST RUN button, and the test operation control mode will appear.
During test running, the Operation LED and Timer LED of the air conditioner body blinks simultaneously.
Set the test operation mode, and the compressor will continue to run regardless of whether the room temperature sensor detects.

▪ With Outdoor Unit

All the indoor units connected to the outdoor unit can be test-operated by push button as next page.

Perform test run for refrigerant system.

You can set "cooling test run" or "heating test run" with the push-button switch on the outdoor unit print circuit board.

Test run setting method

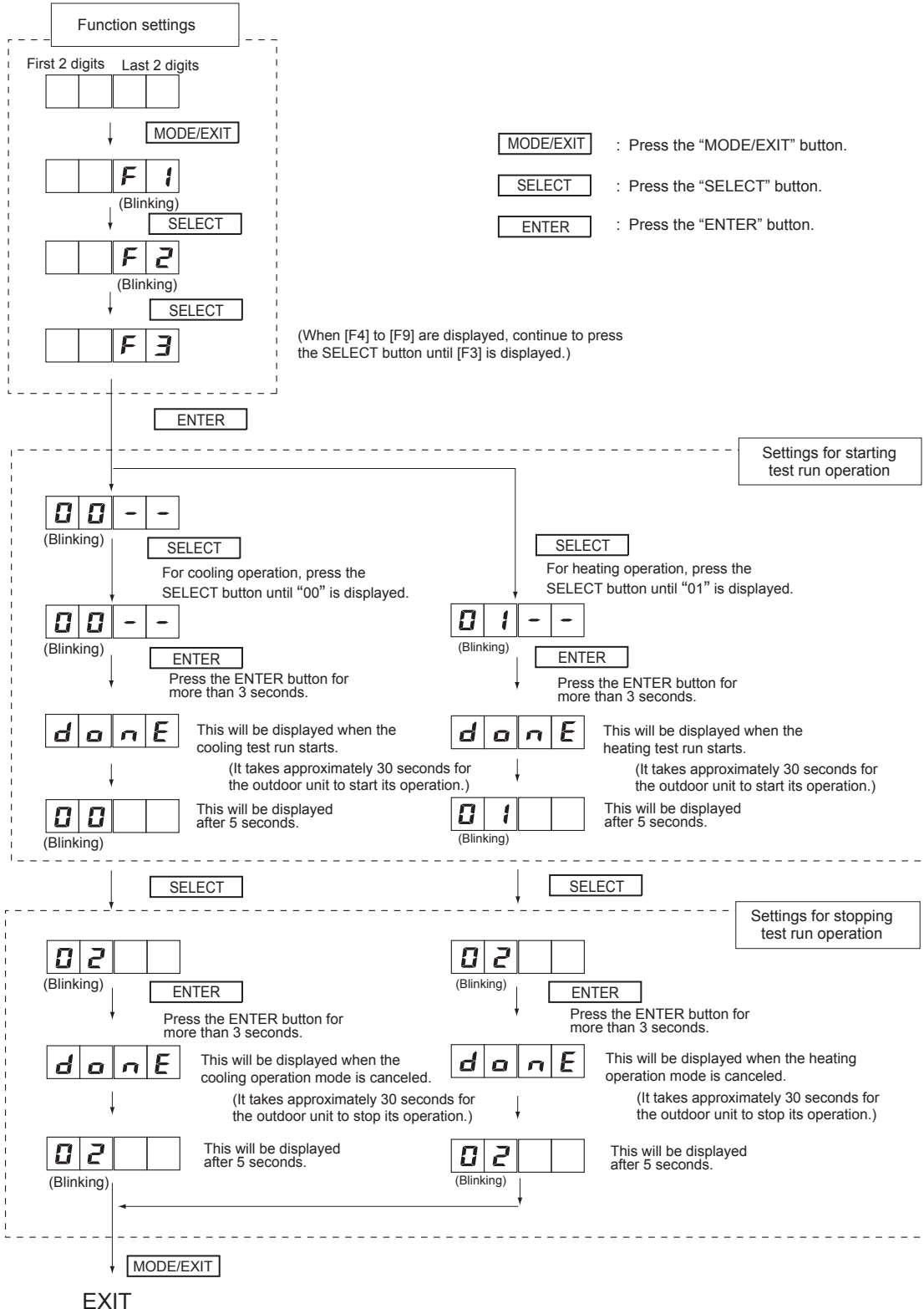

After the test run is complete, turn off the power. Attach the cover of the electrical component box and the front panel of the outdoor unit.

1-11. 4-WAY VALVE EXTENSION SELECT

At the time when the air conditioner is switched from the Cooling mode to Heating mode, the compressor is stopped, and the 4-way valve is switched in 3 minutes later after the compressor stopped.

1-12. AUTO RESTART

When the power was interrupted by a power failure, etc. during operation, the operation contents at that time are memorized and when power is recovered, operation is automatically resumed with the memorized operation contents.

(Table 11 : Operation contents memorized when the power is interrupted)

	Wireless remote controller	Wired remote controller (When Memory Backup : Disable)	Wired remote controller (When Memory Backup : Enable)	
Operation mode	○	○	○	
Set temperature	○	○	○	
Set air flow	○	○	○	
Thermistor detected position	—	×	○	
Timer mode	○	×	OFF Timer	×
			ON Timer	×
			WEEKLY Timer	×
			Temperature	○
			SET BACK Timer	○

○ : Memorize
 × : Not memorize

*It is necessary to set on the DIP-SW1-No,6 of the wired remote controller, to enable the memory backup.
 Refer to the installation manual of wired remote controller for details.

1-13. MANUAL AUTO OPERATION

If MANUAL / AUTO Button is pushed continuous from 3 seconds to 10 seconds, manual auto operation will start.

If the remote control is lost or battery power dissipated, this function will work without the remote control.

(Table 12 : Manual auto operation control)

Functions	All models
OPERATION MODE	Auto changeover
SETTING TEMP.	75.2°F(24°C)
FAN MODE	Auto
VERTICAL LOUVER	NORMAL
HORIZONTAL LOUVER	NORMAL
TIMER MODE	Continuous (No timer setting available)
SWING OPERATION	OFF
ECONOMY	OFF

1-14. FORCED COOLING OPERATION

Forced cooling operation is started when pressing MANUAL AUTO button for 10 seconds or more. During the forced cooling operation, it operates regardless of room temperature sensor. Operation LED and timer LED blink during the forced cooling operation. They blink for 1 second ON and 1 second OFF on both operation LED and timer LED (same as test operation). Forced cooling operation is released after 60 minutes of starting operation. FORCED COOLING OPERATION will start as shown in Table 12.

(Table 13 : Detail of forced cooling operation)

	Forced cooling operation
OPERATION MODE	Cooling
FAN CONT. MODE	Hi
TIMER MODE	-
SETTING TEMP.	Room temperature is not controlled
SETTING LOUVER	Horizontal
SWING	OFF

1-15. COMPRESSOR PREHEATING

The compressor temperature is maintained more than ambient temperature (other refrigerant cycle parts) for the following reasons.

- 1.To Prevent the compressor damage by the cold start.
- 2.Speed up the ascent rate of the refrigerant, and the separation of the refrigerant and oil is furthered.

(Table 14 : Detail of compressor preheating operation)

	Judgment condition	Operation
Start condition	Outdoor temperature $\leq 89.6^{\circ}\text{F}$ (32°C) and 30 minutes after the compressor stop	Crankcase heater : ON
Release condition	Outdoor temperature $\geq 93.2^{\circ}\text{F}$ (34°C) or Operating instruction to outdoor unit	Crankcase heater : OFF

1-16. MINIMUM HEAT OPERATION

MINIMUM HEAT OPERATION functions by pressing MIN HEAT button on the remote controller. It is almost the same operation as below settings.

(Table 15 : Detail of MINIMUM HEAT OPERATION)

Operation mode	Heating
Setting temperature	50°F (10°C)
Defrost operation	Normal operation
Oil recovery operation	Normal operation
Fan mode	×
Louver setting	○
Swing setting	×
LED indication	Only ECONOMY LED (Green)
ON / OFF timer	×

1-17. DEFROST OPERATION CONTROL

1. CONDITION OF STARTING THE DEFROST OPERATION

The defrost operation starts as shown in the following Table 16, 17 and 18.

(Table 16 : Condition of normal defrost operation)

Normal defrost	Compressor integrating operation time	
	Less than 35 minutes	Over 35 minutes
	Does not operate	Outdoor temperature $\geq 14^{\circ}\text{F}$ (-10°C) and Heat exchanger temperature $\leq 23^{\circ}\text{F}$ (-17°C)
		Outdoor temperature $< 14^{\circ}\text{F}$ (-10°C) and Heat exchanger temperature $\leq -14^{\circ}\text{F}$ (7°C)
Outdoor temperature $< 14^{\circ}\text{F}$ (-10°C) and Heat exchanger temperature $\leq -4^{\circ}\text{F}$ (-20°C)		

(Table 17 : Condition of integrating defrost operation)

Integrating defrost	Compressor integrating operation time		
	Less than 210 minutes	Over 210 minutes	Over 240 minutes
	Does not operate	Compressor stop and Outdoor temperature $\leq 35.6^{\circ}\text{F}$ (2°C)	Outdoor unit heat exchanger $\leq 26.6^{\circ}\text{F}$ (-3°C) temperature

(Table 18 : Condition of Integrating (OFF count) defrost operation)

Integrating defrost (OFF count defrost)	Compressor continuous operation time
	Less than 10 minutes
	Outdoor temperature $\leq 35.6^{\circ}\text{F}$ (2°C) and Compressor OFF count : 40 times

* If any defrost operated, "compressor integrating operation time" and "compressor OFF count" are cleared.

2. CONDITION OF THE DEFROST OPERATION COMPLETION

Defrost operation is released when the conditions becomes as shown in Table 19.

(Table 19 : Condition of defrost release)

Release Condition
Outdoor heat exchanger temperature is higher than 53.6°F (12°C) or Compressor operation time has passed 15 minutes.

3. Defrost Flow Chart

The defrosting shall proceed by the integrating operation time, outdoor temperature and outdoor heat exchanger temperature as follows.

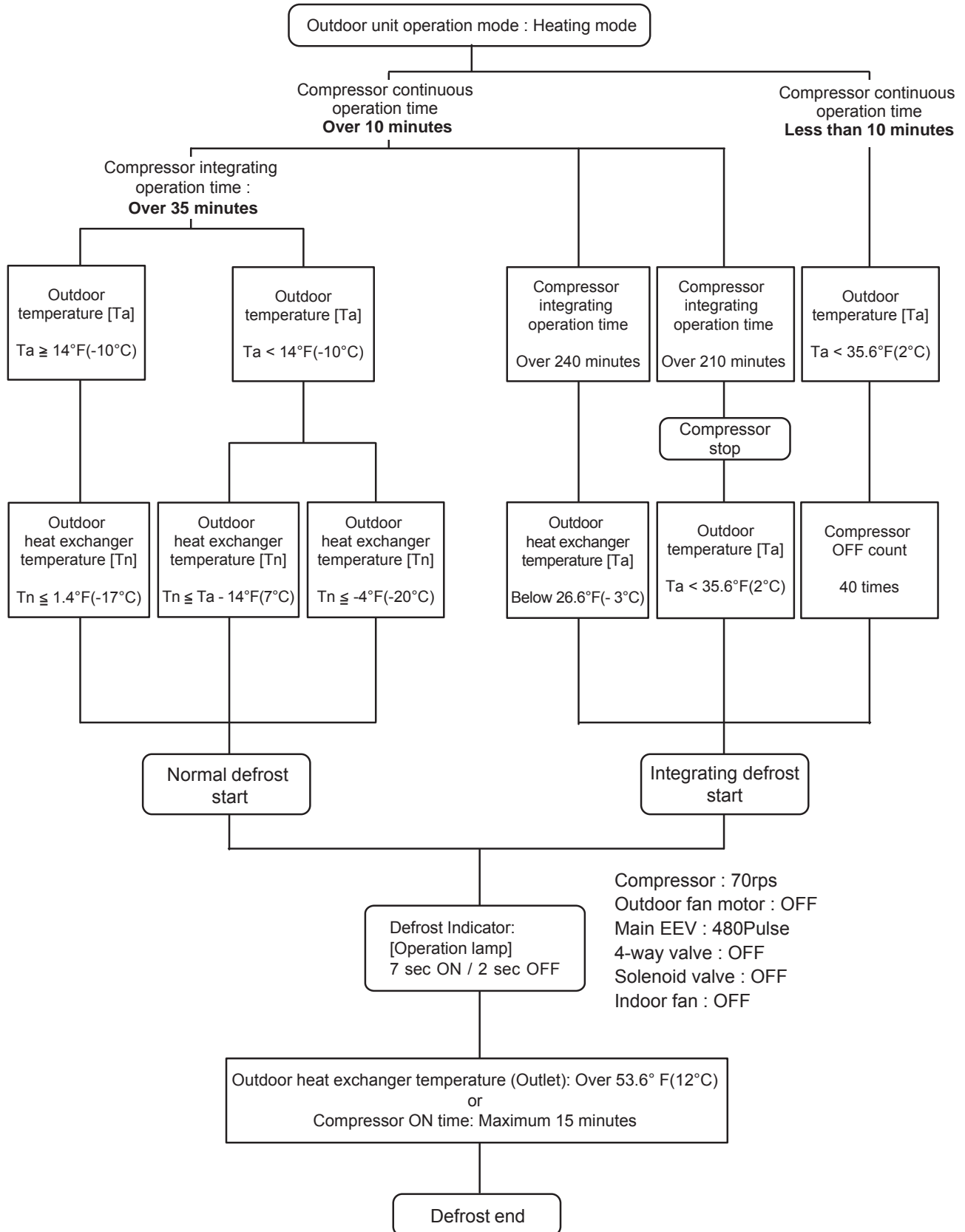

1-18. OFF DEFROST OPERATION CONTROL

When operation stops in the [Heating operation] mode, if frost is adhered to the outdoor unit heat exchanger, the defrost operation will proceed automatically. In this time, the outdoor unit will allow the heat exchanger to defrost, and then stop.

1. OFF DEFROST OPERATION CONDITION

When heating operation stops, all of following conditions are met, OFF defrost operation starts.

1. Compressor operation integrating time lasts for more than 30 minutes.
2. Compressor countinuous operation time lasts for more than 10 minutes.
3. Outdoor unit heat exchanger temperature is less than 24.8°F(-4°C).

If the operation stops in defrost operation, defrost operation is kept untill the it is completed.

2. OFF DEFROST RELEASE CONDITION

OFF defrost operation is released when the conditions becomes as shown in Table 31

(Table 20 : OFF Defrost Release Condition)

Release Condition
Outdoor heat exchanger temperature is higher than 53.6°F(12°C) or Compressor operation time has passed 15 minutes.

OFF Defrost Flow Chart

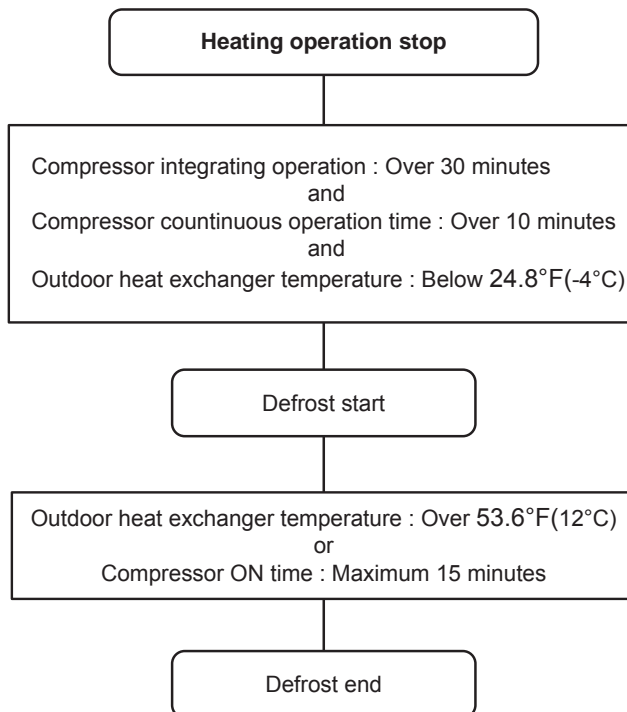

1-19. OIL RECOVERY OPERATION

Outdoor unit operates by cooling refrigerant cycle for recover the refrigerant oil to the compressor

1. Cooling oil recovery operation

< Start condition >

It operates forcibly from the compressor integrating time in Cooling and Dry mode.

① Condition of the oil recovery operates after 1 hour

- (1). First time after power ON
- (2). When the operation mode changes from Heating to Cooling. (only first time)

② Condition of the oil recovery operates after 3 hour

Without condition ①

< Operation >

Compressor : Over 50rps
Outdoor fan : Normal operation
4 way valve : OFF

< Release condition >

*2~7 minutes has passed from the start of oil recovery operation.

2. Heating oil recovery operation

< Start condition >

It operates forcibly when the compressor integrating operation time becomes 12 hours.



< Operation >

Refrigerant cycle is changed to the cooling cycle temporarily.

Compressor : Fixed 50rps
Outdoor fan : Step2 (290rpm)
4 way valve : OFF

< Release condition >

*1~5 minutes has passed from the start of oil recovery operation.

During the oil recovery operation,  appears on the display of wired and central remote controller, and  appears on the simple remote controller. The operation indicators (LED) of the indoor units flash slowly.

***Operation time changes from the progress status of oil recovery.**

1-20. FRESH AIR CONTROL(For AU / AR type)

The fan motor for Fresh Air is operated in synchronization with the indoor fan operation as shown in Figure 22.

(Fig. 22 : Fresh Air control)

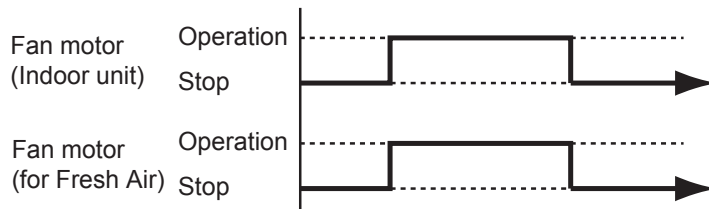

*It needs the external relay and power supply.

1-21. EXTERNAL ELECTRICAL HEATER CONTROL (For AR type)

The External Electrical Heater is operated as below.

< Heater : ON condition >

When all of the following conditions are met, external electrical heater will operate according to Figure 23.

System type	Heatpump
Operation mode	Heating
Compressor	ON
Indoor fan	ON (S-Lo is excluded)

< Heater : OFF condition >

- 1). When one of the ON conditions is not met.
- 2). When Defrost operation or Oil recovery operation starts

(Fig. 23 : External electrical heater control)

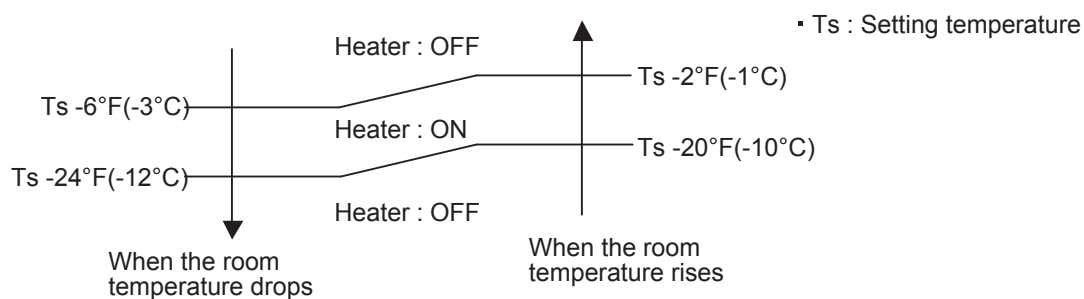

1-22. DRAIN PUMP OPERATION

During Cooling / Dry mode

1. When the compressor starts, the drain pump starts simultaneously.
2. The drain pump operates continuously for 3 minutes after the compressor is turned off.
3. When the compressor stops by the "Anti- freezing protection", the drain pump is turned off in 1 hour after the compressor stops.
4. When the water level in the drain pan rises up and then the float switch functions:
 - ① The compressor, indoor and outdoor fan motor operation are stopped.
 - ② Drain pump operates continuously for 3 minutes after the float switch is turned off.
 - (Almost condensing water may be drained)
 - ③ The indoor unit fan motor operates after the float switch is turned off.
5. When the float switch turns ON continuously for 3 minutes, "FAILURE INDICATION" operates. (It is necessary to turn off power for release it.)
6. When the float switch turns OFF less than 3 minutes, the unit starts Cooling operation.

(Fig. 24 : Detail of Drain Pump Operation in Cooling / Dry)

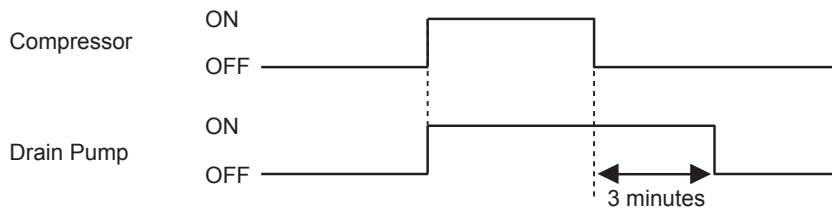

<Float Switch turns OFF less than 3 minutes>

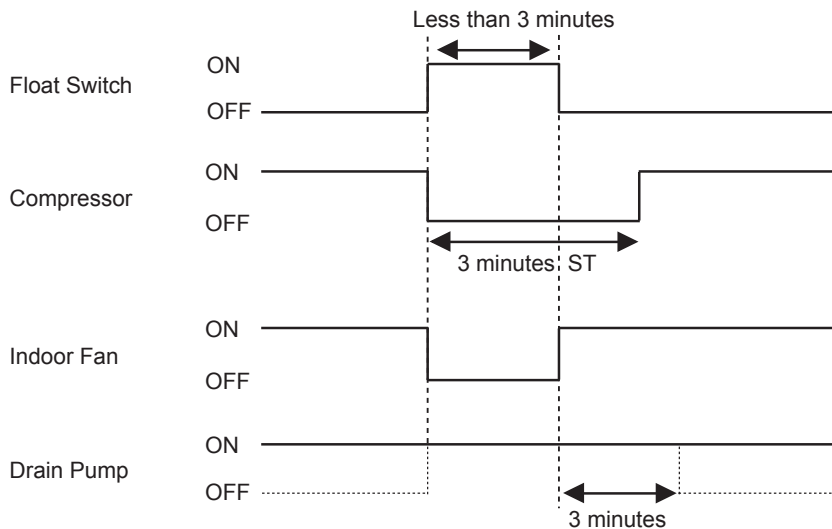

During HEATING / FAN mode / Stop operation

1. When the water level in the drain pan rises up and then the float switch functions:
 - ① Drain pump operates continuously for 3 minutes after the float switch is turned off.
 - (Almost condensing water may be drained)
2. When the float switch turns ON continuously for 3 minutes, "FAILURE INDICATION" operates. Thereafter, even if the float switch turns OFF, the "FAILURE INDICATION" is not released. (It is necessary to turn off power for release it.)

(Fig. 25 : Detail of Drain Pump Operation in Heating)

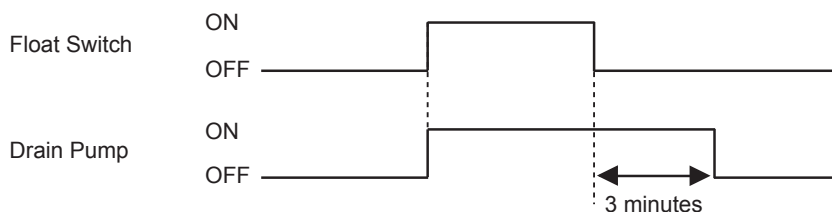

1-23. ECONOMY OPERATION

ECONOMY OPERATION functions by pressing ECONOMY button on the remote controller or Home controller, it is almost the same operation as below settings.

(Table 20 : Detail of ECONOMY OPERATION) Ts : Setting temperature

Operation mode	Outdoor unit limit current value	Setting temperature correction	Indoor fan speed	Indoor unit LED	Wired remote controller display
Cooling	*17.0A	Ts + 2°F (Ts+1°C)	Normal operation <small>(When only fan mode, air flow downs 1 step)</small>	OPERATION : Lighting ECONOMY : Lighting	 : Lighting
Heating		Ts - 2°F (Ts-1°C)			
Dry		Ts + 2°F (Ts+1°C)			
Auto		Cooling : Ts + 2°F (Ts+1°C) Heating : Ts -2°F (Ts-1°C)			

During ECONOMY OPERATION,
 *limit current value of outdoor unit is changed to 17.0A
 When also "ENERGY SAVING PEAK CUT FUNCTION" mode is effective, the outdoor unit will operate by lower current.

- ECONOMY OPERATION does not operate in following conditions.
- Compressor start-up process
 - Defrost operation
 - Oil recovery operation
 - Minimum heat operation

- < Release conditions of ECONOMY OPERATION >
- 1, When the ECONOMY button on the remote controller is pressed.
 - 2, When the indoor unit start-up by MANUAL AUTO button on the indoor unit.
 (When the operation is stopped by MANUAL AUTO button, it is not released.)

1-24. ENERGY SAVING PEAK CUT FUNCTION

The current value is limited to reduce the power consumption by external input terminal 3(CN933). When this function, "CURRENT OVERLOAD OPERATION", "ECONOMY OPERATION" and "LOW NOISE OPERATION" are effective, the outdoor unit will operate by lowest current of them.

(Table 21 : Outline of ENERGY SAVING PEAK CUT FUNCTION)

	MODE1 0% (Forced thermostat-OFF)	MODE2 50%	MODE3 75%	MODE4 100% (Rated)
Cooling mode Dry mode Heating mode	Compressor stop	11.0A	17.0A	22.5A

*Percentage is rated electrical power ratio

ENERGY SAVING PEAK CUT OPERATION does not operate in following conditions.

- Compressor start-up process
- Defrost operation
- Oil recovery operation
- Check run

1-25. LOW NOISE MODE

The outdoor unit operation changes from the capacity priority to the low noise priority by external input 1(CN931).

The compressor speed and outdoor fan speed are limited as following table.

When "CURRENT OVERLOAD OPERATION", "ECONOMY OPERATION" and "PEAK CUT OPERATION" are effective, the outdoor unit will operate by lowest current of them.

(Table 22 : Detail of LOW NOISE OPERATION)

		MODE1	MODE2	MODE3
Cooling mode Dry mode	Limit compressor speed	52rps	45rps	36rps
	Limit fan speed	690rpm	580rpm	390rpm
Heating mode	Limit compressor speed	55rps	49rps	42rps
	Limit fan speed	690rpm	580rpm	390rpm

(Relative to the rated sound pressure level)

*The performance drops when operating in the LOW NOISE OPERATION.

LOW NOISE OPERATION does not operate in following conditions.

- Compressor start-up process
- Defrost operation
- Oil recovery operation
- Check run

1-26. VARIOUS PROTECTIONS

1. DISCHARGE GAS TEMPERATURE OVER RISE PREVENTION CONTROL

During the compressor in operation,
the discharge thermistor will detect discharge gas temperature.
The discharge gas temperature is controlled in the following protections.

Discharge temperature protection 1

<Start condition>

Discharge temperature becomes more than 221°F(105°C).

(Fig. 26 : Discharge temperature control)

<Operation>

The compressor speed -20rps every 120 seconds.
If the compressor operates at minimum speed for 120 seconds,
and the release condition isn't met, it will be stopped.

Discharge
temperature
239°F
(115°C)

Comp. stop

Comp. speed -20rps every 120 sec.

<Release condition>

When the discharge temperature becomes lower than
212°F(100°C), the compressor returns to the normal operation.
If the compressor was stopped by protection, it will restart
after 3 minutes ST.

221°F
(105°C)

Hold

158°F
(70°C)

Release protection 2

Discharge temperature protection 2

<Start condition>

Discharge temperature becomes more than 239°F(115°C).

<Operation>

The compressor is stopped, and it does not restart for 7 minutes.

<Release condition>

When the discharge temperature becomes lower than 158°F(70°C), the compressor restarts.

If the Discharge temperature protection 2 operates 2 times within 24 hours,
discharge temperature error will occur. **<Permanent stop>**

An error code is displayed each controller, it is reset by only the main power supply reset.

2. COMPRESSOR TEMPERATURE PROTECTION CONTROL

<Start condition>

When the compressor temperature thermistor detects more than 233.6°F (112°C).

<Operation>

The compressor is stopped at once.

<Release condition>

The compressor temperature becomes lower than 176°F(80°C) after 3 minutes ST.

If the Compressor temperature protection operates 2 times within 24 hours,
discharge temperature error will occur. **<Permanent stop>**

An error code is displayed each controller, it is reset by only the main power supply reset.

3. HEAT SINK TEMPERATURE PROTECTION CONTROL

During the compressor in operation, heat sink temperature thermistor (Built-in IPM) will detect heatsink temperature. It is controlled in the following protections. Heat sink protection 1 and 2 operates at the same time, if each conditions are met.

Heatsink temperature protection 1

<Start condition>
When the heat sink temperature becomes more than 185°F(85°C).

<Operation>
Outdoor unit fan +1 STEP (rise) every 30 seconds.

<Release condition>
When the heat sink temperature becomes lower than 176°F(80°C) and the outdoor fan returns to the normal operation.

Heatsink temperature protection 2

<Start condition>
When the heat sink temperature becomes more than 194°F(90°C).

<Operation>
Compressor speed -10rps every 30 seconds.
If the compressor operates at minimum speed for 120 seconds, and the release condition isn't met, it will be stopped.

<Release condition>
When the heat sink temperature becomes lower than 185°F(85°C), the outdoor fan to the normal operation. If the compressor was stopped by protection, it will restart after 3 minutes ST.

Heatsink temperature protection 3

<Start condition>
When the heat sink temperature becomes more than 212°F(100°C).

<Operation>
Compressor is stopped

<Release condition>
When the heat sink temperature becomes lower than 185°F(85°C) and after 3 minutes ST, the compressor restarts.

(Fig. 27 : Heat sink temperature control)

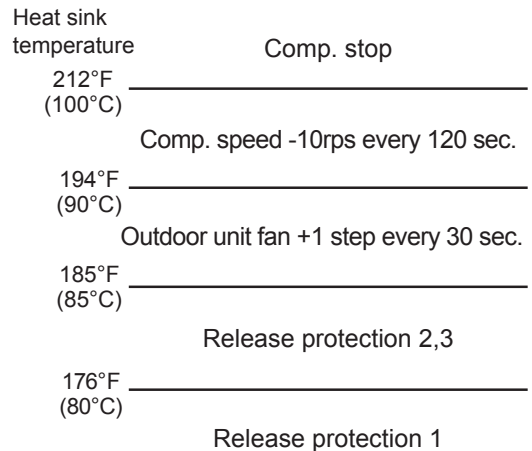

4. CURRENT RELEASE CONTROL

The compressor speed is controlled so that the outdoor unit input current does not exceeds the current limit value is decided by the outdoor temperature.

When "ECONOMY OPERATION" or "PEAK CUT OPERATION" are effective, the outdoor unit will operate by lowest current.

When the outdoor unit input current reaches to the control value, the compressor speed -1rps every 1 second till the release value.

Then, if the compressor operates at minimum speed and the input current doesn't reach to the release value, the compressor is stopped.

(Table 23 : Current release operation value / Release value)

Ta : Outdoor temperature

	Outdoor temperature [Ta]	Current value [A] (Control / Release)			
		Normal	Low noise mode 1	Low noise mode 2	Low noise mode 3
Cooling Dry	$122^{\circ}\text{F}(50^{\circ}\text{C}) \leq \text{Ta}$	17.0 / 16.5	14.0 / 13.5	13.0 / 12.5	10.5 / 10.0
	$116.6^{\circ}\text{F}(47^{\circ}\text{C}) \leq \text{Ta} < 122^{\circ}\text{F}(50^{\circ}\text{C})$	18.0 / 17.5	16.5 / 16.0	15.0 / 14.5	12.5 / 12.0
	$104^{\circ}\text{F}(40^{\circ}\text{C}) \leq \text{Ta} < 116.6^{\circ}\text{F}(47^{\circ}\text{C})$	22.0 / 21.5	17.0 / 16.5	15.5 / 15.0	13.0 / 12.5
	$104^{\circ}\text{F}(35^{\circ}\text{C}) \leq \text{Ta} < 104^{\circ}\text{F}(40^{\circ}\text{C})$	26.0 / 25.5	22.0 / 21.5	17.0 / 16.5	14.0 / 13.5
	$86^{\circ}\text{F}(30^{\circ}\text{C}) \leq \text{Ta} < 104^{\circ}\text{F}(35^{\circ}\text{C})$	22.0 / 21.5	22.0 / 21.5	17.0 / 16.5	14.0 / 13.5
	$20^{\circ}\text{F}(30^{\circ}\text{C}) \leq \text{Ta} < 86^{\circ}\text{F}(30^{\circ}\text{C})$	22.0 / 21.5	22.0 / 21.5	19.0 / 18.5	16.0 / 15.5
	$50^{\circ}\text{F}(10^{\circ}\text{C}) \leq \text{Ta} < 20^{\circ}\text{F}(30^{\circ}\text{C})$	*20.5 / 20.0	*20.5 / 20.0	*20.5 / 20.0	*20.5 / 20.0
	$23^{\circ}\text{F}(-5^{\circ}\text{C}) \leq \text{Ta} < 50^{\circ}\text{F}(10^{\circ}\text{C})$	*20.5 / 20.0	*20.5 / 20.0	*20.5 / 20.0	*20.5 / 20.0
$\text{Ta} < 23^{\circ}\text{F}(-5^{\circ}\text{C})$	*20.5 / 20.0	*20.5 / 20.0	*20.5 / 20.0	*20.5 / 20.0	
Heating	$75.2^{\circ}\text{F}(24^{\circ}\text{C}) \leq \text{Ta}$	19.0 / 18.5	19.0 / 18.5	19.0 / 18.5	19.0 / 18.5
	$62.6^{\circ}\text{F}(17^{\circ}\text{C}) \leq \text{Ta} < 75.2^{\circ}\text{F}(24^{\circ}\text{C})$	26.0 / 25.5	26.0 / 25.5	26.0 / 25.5	23.5 / 23.0
	$53.6^{\circ}\text{F}(12^{\circ}\text{C}) \leq \text{Ta} < 62.6^{\circ}\text{F}(17^{\circ}\text{C})$	26.0 / 25.5	26.0 / 25.5	26.0 / 25.5	23.5 / 23.0
	$41^{\circ}\text{F}(5^{\circ}\text{C}) \leq \text{Ta} < 53.6^{\circ}\text{F}(12^{\circ}\text{C})$	26.0 / 25.5	26.0 / 25.5	26.0 / 25.5	23.5 / 23.0
	$30.2^{\circ}\text{F}(-1^{\circ}\text{C}) \leq \text{Ta} < 41^{\circ}\text{F}(5^{\circ}\text{C})$	26.0 / 25.5	26.0 / 25.5	26.0 / 25.5	23.5 / 23.0
	$5^{\circ}\text{F}(-15^{\circ}\text{C}) \leq \text{Ta} < 30.2^{\circ}\text{F}(-1^{\circ}\text{C})$	26.0 / 25.5	26.0 / 25.5	26.0 / 25.5	23.5 / 23.0
	$\text{Ta} < 5^{\circ}\text{F}(-15^{\circ}\text{C})$	26.0 / 25.5	26.0 / 25.5	26.0 / 25.5	23.5 / 23.0

*Current value(Control / Release) is different from the operating fan step of the outdoor unit.
(Above case is more than 4 STEP, refer to outdoor unit fan table.)

Cooling Dry	$50^{\circ}\text{F}(10^{\circ}\text{C}) \leq \text{Ta} < 20^{\circ}\text{F}(30^{\circ}\text{C})$	STEP 0, 1 : 11.0 / 10.5
	$23^{\circ}\text{F}(-5^{\circ}\text{C}) \leq \text{Ta} < 50^{\circ}\text{F}(10^{\circ}\text{C})$	STEP 2 : 13.5 / 13.0
	$\leq \text{Ta} < 23^{\circ}\text{F}(-5^{\circ}\text{C})$	STEP 3 : 16.5 / 16.0

5 . HIGH PRESSURE PROTECTION CONTROL

During the compressor in operation,
When the discharge high pressure sensor will detect the high pressure sensor.
The high pressure is controlled in the following protections.

HIGH PRESSURE PROTECTION 1

· During Cooling / Dry mode

<Start and Release condition>

When the compressor speed meets following conditions.

(Table 24 : Cooling / Dry high pressure protection control)

Cooling Dry	Compressor speed [rps]	High pressure	
		Control	Release
	$rps \leq 20$	HP \geq 478PSI	HP \leq 451PSI
	$20 < rps \leq 30$	HP \geq 543PSI	HP \leq 530PSI
	$30 < rps$	HP \geq 580PSI	HP \leq 551PSI

<Operation>

The compressor speed -5rps every 60 seconds.

If the compressor operates at minimum speed for 60 seconds and the release condition isn't met, it will be stopped.

· During Heating mode

<Start and Release condition 1>

When the compressor speed meets following conditions.

(Table 25 : Heating high pressure protection control)

Heating	Compressor speed [rps]	High pressure	
		Control	Release
	$rps \leq 20$	HP \geq 478PSI	HP \leq 451PSI
	$20 < rps \leq 90$	HP \geq 507PSI	HP \leq 530PSI
	$90 < rps$	HP \geq 478PSI	HP \leq 451PSI

<Operation>

The compressor speed -5rps every 60 seconds.

If the compressor operates at minimum speed for 60 seconds.

<Release condition 2>

If the compressor was stopped by protection, it will restart after 3 minutes ST and high pressure is lower than 435PSI.

HIGH PRESSURE PROTECTION 2

(Fig. 28 : High pressure protection 2)

<Start condition>

High pressure sensor detects more than 594PSI.

<Operation>

Compressor is stopped.

<Release condition>

When the high pressure sensor detects lower than 435PSI and after 3 minutes ST, the compressor restarts.

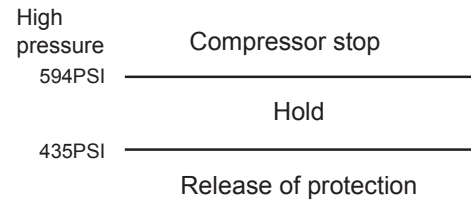

HIGH PRESSURE PROTECTION 3

<Start condition>

When the pressure switch becomes OFF (Open : more than 609.2 PSI), the compressor is stopped.

<Operation>

Compressor is stopped.

<Release condition>

When the pressure switch becomes ON (Close : lower than 464.1 PSI) and after 3 minutes ST, the compressor restarts.

6. LOW PRESSURE PROTECTION CONTROL

LOW PRESSURE PROTECTION 1 (For Cooling, Dry and Heating mode)

<Start condition>

After the compressor operates for 1 minute, and low pressure sensor detects lower than 7.25PSI for 5 minutes.

(Fig. 29 : Low pressure protection 1)

<Operation>

Compressor is stopped.

<Release condition>

Compressor restarts after 3 minutes ST.

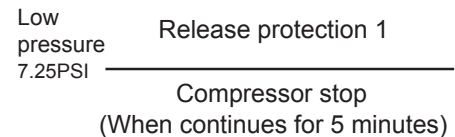

If the Low pressure protection 1 operates 5 times within 2 hours, Low pressure error will occur. <Permanent stop>

An error code is displayed each controller, it is reset by only the main power supply reset.

LOW PRESSURE PROTECTION 2 (For Heating mode)

<Start condition>

The compressor operates for 10 minutes, and low pressure sensor detects lower than 23.2PSI for 1 minute.

(Fig. 30: Low pressure protection 2)

<Operation>

The compressor speed -5rps every 60 seconds till the release condition.

If the compressor operates at minimum speed for 60 seconds, and the release condition isn't met, the compressor is stopped.

<Release condition>

Low pressure sensor detects more than 26.0PSI, and after 3 minutes ST.

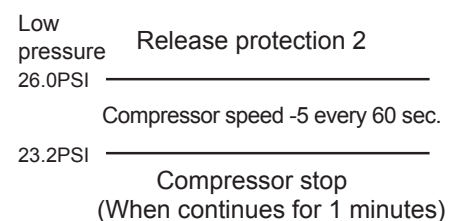

LOW PRESSURE PROTECTION 3 (For Cooling / Dry mode)

<Start condition>

During the compressor in operation, low pressure sensor detects lower than 21.7PSI.

(Fig. 31 : Low pressure protection 3)

<Operation>

Main EEV of Branch Box opens until the release condition.

<Release condition>

Low pressure sensor detects more than 24.6PSI.
If the compressor stopped, it restarts after 3 minutes ST.

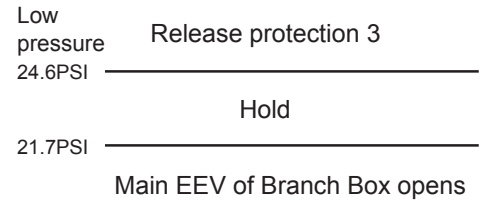

7. ANTIFREEZING CONTROL (Cooling and Dry mode)

To prevent the indoor unit heat exchanger freezing.

<Start condition>

When the indoor heat exchanger temperature sensor detects lower than 37.4°F(3°C).

<Operation>

Main EEV of branch box is closed.

<Release condition>

When indoor heat exchanger becomes more than 44.6°F(7°C).

8. EEV FULL CLOSE PROTECTION CONTROL (Heating mode)

Operation condition of EEV is checked from the temperature difference indoor heat exchanger and room temperature.

<Start condition>

When all the following conditions are met for the 2 times in a row.

1. During compressor in operation
2. After 20 minutes from compressor start-up.
3. Indoor unit heat exchanger temperature - Room temperature < 8°F(4°C)

<Operation>

Outdoor unit is stopped and EEV is initialized.

<Release condition>

After 3 minutes ST, compressor will restart.

Hybrid Flex Inverter System

2. TROUBLE SHOOTING

2. TROUBLESHOOTING

2-1 Service maintenance for Hybrid Flex Inverter System

2-1-1 Features

Enhanced installability and maintenance.

<Product>

- 1) Multi-room --> Many pipes and lines
- 2) Branch box --> Pipes and line
- 3) Increased power supply points --> Outdoor units and branch boxes

<Functions>

- The conditions of each lines are automatically checked.
- Controller in outdoor units.
- 7-segment lamp in outdoor units.

● Check operation

- Lines and pipes of branch boxes are automatically checked.
- Check result (Fault and right lines) is shown.

● Controller in outdoor units

[Available]

- Cooling and heating test running
- Refrigerant recovery mode
- Local setting function (Outdoor unit function)

● Display in outdoor units

[Available]

- Cooling and heating running condition
- Detail and unit number of error
- Speed of compressor and outdoor fan
- Value detected from sensor

2-1-1 Error code

1) New error codes are adopted.

Lamp flashing, wired remote control, outdoor unit 7-segment (number).

Checked by alphabet.

Current "EE" --> New "Er"

※ Shown in wired remote control, temperature setting.

2) Hybrid Flex Inverter System, error codes

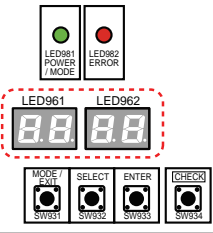
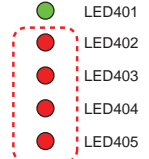
	Error code display	Defective component	Appearance	Object person
Indoor unit	Indoor units lamps, flashing of operation and timer lamps. and continuous flashing of economy lamp.	- Indoor unit error - Abnormal units except indoor units	<input type="radio"/> OPERATION (Green) <input type="radio"/> TIMER (Orange) <input type="radio"/> ECONOMY (Green)	- End user - Installer - Service engineer
Wired remote control	LCD, 7-segment display			
Outdoor unit	Four 7-segment lamps on PCB	- Outdoor unit error - Abnormal units except outdoor units (Indoor unit, Branch-box)		- Service engineer - Installer
Branch box	Four lamps on PCB	- Branch box error, *No exception		

2-1-3 Response procedure at error code display

Case1 : End user

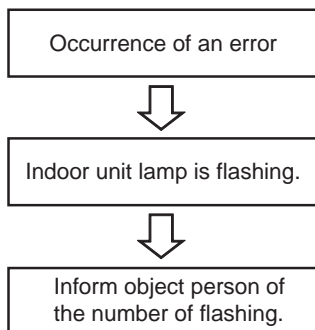

Case2 : Service Engineer

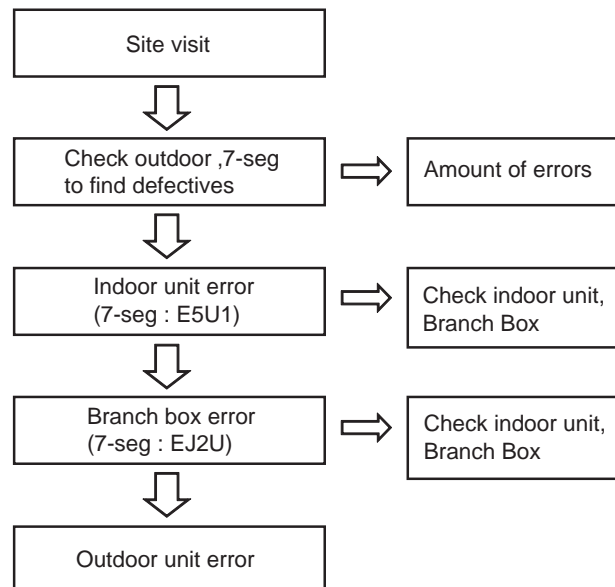

Case3 : Error at construction

After performing the below-described work, repairs, inspections etc., always carry out the Check operation. Normal operation will not be possible without performing the Check operation.

1. Things to confirm before starting the Check operation

To ensure safety, check that the following work, inspections and operations have been completed.

- 1 Check that all work on the piping connecting the outdoor unit , indoor units and branch box has been completed
- 2 Check that all work on the wiring connecting the outdoor unit, indoor units and branch box has been completed
- 3 Is there a gas leakage? (At pipe connections {flang connections and brazed areas})
- 4 Is the system changed with the specified volume of refrigerant?
- 5 Is a breaker installed at the power supply cable of outdoor unit and every branch boxes?
- 6 Are the wires connected to the terminals without looseness, and in accordance with the specifications?
- 7 Is the 3-way valve of the outdoor unit open?(Gas pipe and liquid pipe)
- 8 Is power supplied to the crank case heater for more than 12 hours?
- 9 Has the power supply of the all indoor units turned off?(Remote controller)

2. Restrictions applicable when performing the Check operation

- When the Check run starts, all indoor units connected to the outdoor unit will start to run automatically. During the Check run, you cannot check the operation of the indoor units separately. After the Check run, check the operation of the indoor units separately in normal operation.
- The operable temperature ranges for the Check run are: external temperature -15 to 46°C(5 to 115°F); room temperature for cooling 18 to 46°C(64 to 114°F); room temperature for heating -15 to 37°C(5 to 98°F).
- In the check run, the conditioner will automatically switch between cooling and heating depending on the external temperature and internal temperature.
If the external temperature or internal temperature is outside the above operable temperature range, wait until the temperature is within the operable range and then perform the Check run.
- The Check run can be completed within 1 hour, but may take several hours depending on the external and internal temperature conditions etc.
- Please do not conduct the Check run with all the windows in the room closed. Otherwise the room temperature could get too low or too high.
- Depending on the difference of the room temperature of each room, a judgment may be impossible.

3. Operating procedure for Check run

(●: On, ◎: Blinking, ○: Off)







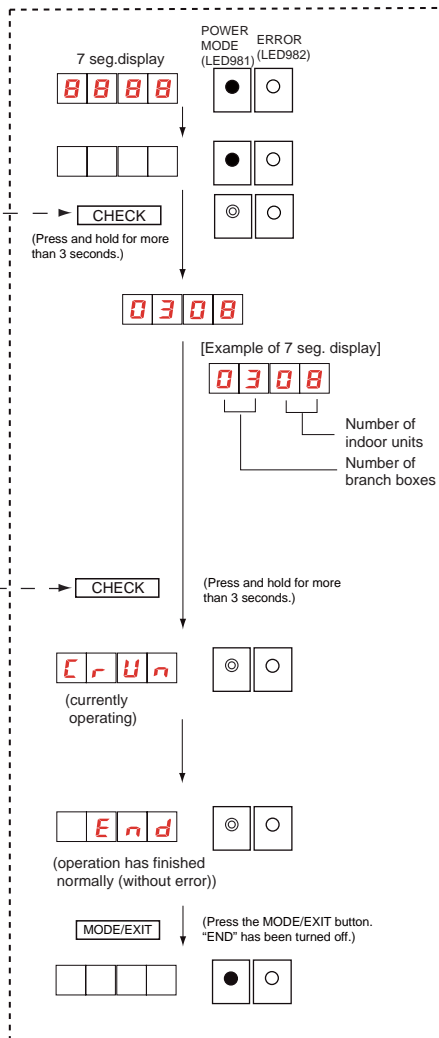

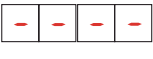

- (1) Turn power on to the outdoor unit, indoor units and branch boxes.
After the displayed number of "8888." has been turned off, press the "CHECK" button.(approximately 2 minutes)
- (2) Press and hold the "CHECK" BUTTO for more than 3 seconds.
- (3) The number of connected branch boxes and indoor units will be displayed on the 7 seg. display. Check that the displayed number matches the actual number of connected units. Do not perform the Check run if the displayed number of units is in error. If the Check run was performed with the number of units in error, check the state of the units and then perform the Check run again.
 - 1 If the displayed number of units matches the installed number, go to (4)
 - 2 If the displayed number does not match the installed number, check the following.
 - Are all the Branch boxes turned on? → Check that the Branch boxes are turned on, and go to (4).
 - Are connection cables connected to all of the indoor units? → Turn of the power, connect the Connection cable and go to (1).
- (4) Press and hold the "CHECK" button again for more than 3 seconds.
 - The Check run will start.

In the Check run, the following items will be checked.

 - 1 The wiring and piping between the indoor units and the Branch box
 - 2 Valve opening
 - To make an enforced stop, press the "MODE/EXIT" button. You cannot execute the stop operation using the remote control.
 - To prevent electric shock, close the service panel during the Check run.
- (5) The Check run will stop automatically after allitems are completed. When an error occurs, consult the following error display items. Correct the error, and carry out the Check run again.
 - When the error display disappear even the measures for error are taken, switch on the power again after turning off the power. When the power is turned on again after turned off, wait approx. 10 minutes and turn on the power again.



4. Error display

Error display		Error item	Contents
(●: On, ◎: Blinking, ○: Off)			
7 seg. display	LED lamp		
 (blinking)		Indeterminable	The external or room temperature is outside the operable range. The air conditioner will temporarily permit normal operation, but the Check run should be carried out again at a later date when the temperatures are within the operable ranges.
		Wiring number error	The number of wirings between indoor unit and branch box is not correct. Turn off all the units, and check number of connected wires. After correcting the error, turn on the power and carry out the Check run again.
		Pipe number error	The number of wirings between indoor unit and branch box is not correct. Turn off all the units, and check number of connected wires. After correcting the error, turn on the power and carry out the Check run again. ※ If the number of pipes is correct, the internal heat-exchanger thermistor or branch box piping thermistor may have come out of its holder, or a coil may have come out of an expansion valve. In this case, please contact Service personnel.
(example)		Wiring error	A wiring error has occurred. The location at which the wiring error has been determined will be displayed 7 seg. display. If there are multiple wiring error locations, the display will cycle through the locations, switching every 2 seconds. After performing the following operation, turn off the power and correct the wiring. <ul style="list-style-type: none"> • Note down the content of the wiring error. • Note down the number of blinks of the green LED on the PCB of the branch box. (The number of blinks indicates the device number of the Branch box) After correcting the wiring, turn on the power and carry out the Check run again.
			(In the case of the diagram) Connect the connection cable which is connected to the terminal A of Branch box (Primary) to the terminal B on Branch box (Secondary 2).
		unit error	This is a unit error. * For error content, please refer to "11.2. Error display mode".

1 A 3 b

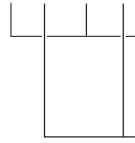







- 1: Branch box-Primary
- 2: Branch box-Secondary 1
- 3: Branch box-Secondary 2
- a: Branch box-TerminalA
- b: Branch box-TerminalB
- c: Branch box-TerminalC

2-2 NORMAL OPERATION

2-2-1 Normal status for Indoor Unit Display

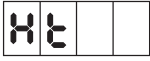
Indication type	Indication Lamp	Flashing Pattern
Operation	Operation LED	Continuous lighting
Timer	Timer LED	Continuous lighting
Filter Sign	Economy LED	<p>ON OFF</p> <p>21 sec</p> <p>0.8 sec</p> <p>1 cycle</p>
Power Failure	Operation LED	<p>ON OFF</p> <p>0.5 sec</p> <p>0.5 sec</p>
	Timer LED	<p>ON OFF</p> <p>0.5 sec</p> <p>0.5 sec</p>
Test Operation	Operation LED	<p>ON OFF</p> <p>1 sec</p> <p>1 sec</p>
Compulsion Cooling	Timer LED	<p>ON OFF</p> <p>1 sec</p> <p>1 sec</p>
Defrosting	Operation LED	<p>ON OFF</p> <p>7 sec</p> <p>2 sec</p>
Oil Recovery		
Mode Mismatch	Operation LED	<p>ON OFF</p> <p>1 sec</p> <p>1 sec</p>
Maintenance Mode	Operation LED	<p>ON OFF</p> <p>1 sec</p> <p>1 sec</p>
	Timer LED	
	Economy LED	

2-2-2 Normal status for Outdoor Unit Display

Indication type	7 Segment LED Pattern	Description
Idling(stop)	 Blank	
Cooling Mode	 "C" OO "L"	During Cooling Mode
Heating Mode	 "H" EA "T"	During Heating Mode
Oil Recovery Operation	 "O" IL "R" ECOVERY	During Oil Recovery Operation
Defrost Operation	 "D" E "F" ROST	During Defrost Operation
Power Saving Operation	 "P" eak "C" ut	During Power Saving Operation
Low Noise Operation	 "L" OW "N" OISE	During Low Noise Operation

2-2-3. Normal status for Branch Box Display

Green	Red				Comment
LED401	LED402	LED403	LED404	LED405	
●	○	○	○	○	The branch box is functioning properly.

● : Lit

○ : Unlit

2-3 ABNORMAL OPERATION

2-3-1 Error status for Indoor Unit Display

Please refer the flashing pattern as follows.

Indoor Unit : ASU7 / 9 / 12 / 18 / 24RLF, AUU9 / 12 / 18RLF, ARU9 / 12 / 18 / 24RLF

The OPERATION, TIMER, ECONOMY lamps operate as follows according to the error contents.

Error Contents	Operation LED	Timer LED	Economy LED	Trouble shooting
Serial Communication Error	1 times flash	1 times flash	Continuous flash	1, 37 ~ 39
Wired Remote Controller Communication Error	1 times flash	2 times flash	Continuous flash	2
Check Run Unfinished	1 times flash	5 times flash	Continuous flash	3
Number of Wires and Pipes Error	2 times flash	1 times flash	Continuous flash	
Indoor Unit Capacity Error	2 times flash	2 times flash	Continuous flash	4
Connected Combination Error	2 times flash	3 times flash	Continuous flash	5
Number of Indoor Units Error Number of Branch boxes Error	2 times flash	4 times flash	Continuous flash	6,7
Indoor Unit Model Information Error EEPROM Access Abnormal	3 times flash	2 times flash	Continuous flash	8
Manual Auto Switch Error	3 times flash	5 times flash	Continuous flash	9
Indoor Room Thermistor Error	4 times flash	1 times flash	Continuous flash	10
Indoor Heat Ex. Thermistor Error	4 times flash	2 times flash	Continuous flash	11
Indoor Unit Fan Motor Error	5 times flash	1 times flash	Continuous flash	12
Drainage Error	5 times flash	3 times flash	Continuous flash	13
Outdoor Unit Model Information Error	6 times flash	2 times flash	Continuous flash	14
Inverter Error	6 times flash	3 times flash	Continuous flash	15
A. F. Voltage Error	6 times flash	4 times flash	Continuous flash	16
Display P.C.B. Communication Error	6 times flash	10 times flash	Continuous flash	46
Discharge Thermistor Error	7 times flash	1 times flash	Continuous flash	17
Compressor Thermistor Error	7 times flash	2 times flash	Continuous flash	18
Heat Ex. Liquid Outlet Thermistor Error	7 times flash	3 times flash	Continuous flash	19
Outdoor Thermistor Error	7 times flash	4 times flash	Continuous flash	20
Suction Gas Thermistor Error	7 times flash	5 times flash	Continuous flash	21
Heat Sink Thermistor Error	7 times flash	7 times flash	Continuous flash	22

Error Contents	Operation LED	Timer LED	Economy LED	Trouble shooting
Sub-Cool Heat Ex.Gas Inlet Thermistor Error Sub-Cool Heat Ex.Gas Outlet Thermistor Error	8 times flash	2 times flash	Continuous flash	23, 24
Liquid Pipe Thermistor Error	8 times flash	3 times flash	Continuous flash	25
Current Sensor Error	8 times flash	4 times flash	Continuous flash	26
Discharge Pressure Sensor Error Suction Pressure Sensor Error High Pressure Switch Error	8 times flash	6 times flash	Continuous flash	27, 28, 29
Over Current Error	9 times flash	4 times flash	Continuous flash	30
Compressor Control Error	9 times flash	5 times flash	Continuous flash	31
Outdoor Unit Fan Motor Error	9 times flash	7 times flash </td <td>Continuous flash</td> <td>32</td>	Continuous flash	32
4 Way Valve Error	9 times flash	9 times flash	Continuous flash	33
Discharge Temp. Error	10 times flash	1 times flash	Continuous flash	34
Compressor Temp. Error	10 times flash	3 times flash	Continuous flash	35
Low Pressure Error	10 times flash	5 times flash	Continuous flash	36
Branch Box Error	13 times flash	2 times flash	Continuous flash	1, 40 ~ 45

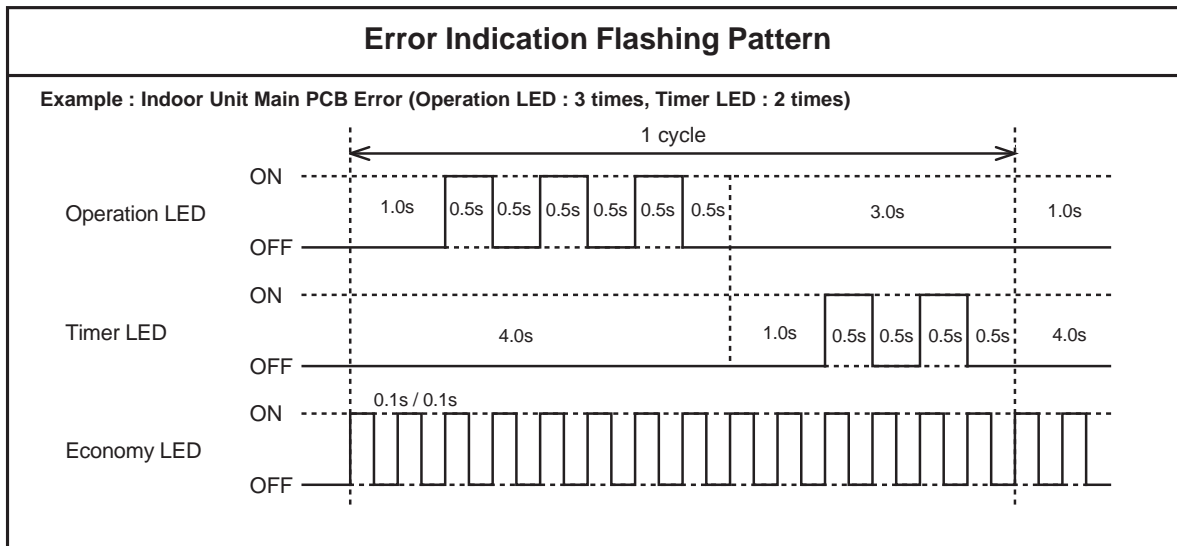

2-3-2 Remote Controller Display

<< SIMPLE REMOTE CONTROLLER >>

ERROR CODE DISPLAY

If an error occurs, the following display will be shown.
 ("Er" will appear in the set room temperature display.)
 If "Er" is displayed, immediately contact authorized service personnel.

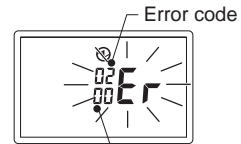

Faulty unit No.
 (Remote controller address)
 Ex. Error code display

<< WIRED REMOTE CONTROLLER >>

ERROR CODE DISPLAY

If an error occurs, the following display will be shown.
 ("Er" will appear in the set room temperature display.)
 If "Er" is displayed, immediately contact authorized service personnel.

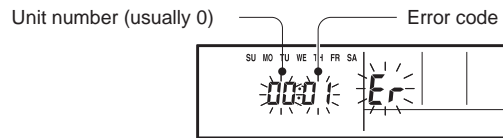

Ex. Error code display

<< HOME CONTROLLER >>

ERROR DISPLAY

To show which indoor unit is the error displayed,
 indoor unit's name and "ERROR" are alternately shown.
 (0.5s indoor unit's name / 0.5s "ERROR")

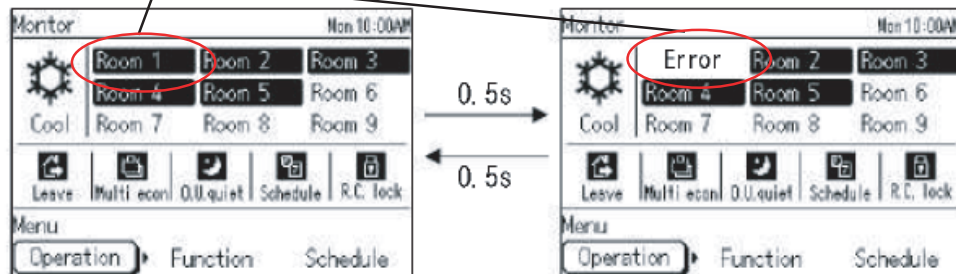

Ex. Error display

2-3-3 Error Code List for Simple and Wired Remote Controller

Error Code	Error Contents	Trouble shooting
1 1	Serial Communication Error	1,37 ~ 39
1 2	Wired Remote Controller Communication Error	2
1 5	Check Run Unfinished	3
2 1	Number of Wires and Pipes Error	
2 2	Indoor Unit Capacity Error	4
2 3	Connected Combination Error	5
2 4	Number of Indoor Units Error Number of Branch boxes Error	6, 7
3 2	Indoor Unit Model Information Error EEPROM Access Abnormal	8
3 5	Manual Auto Switch Error	9
4 1	Indoor Room Thermistor Error	10
4 2	Indoor Heat Ex. Thermistor Error	11
5 1	Indoor Unit Fan Motor Error	12
5 3	Drainage Error	13
6 2	Outdoor Unit Model Information Error	14
6 3	Inverter Error	15
6 A	Display P.C.B. Communication Error	46
7 1	Discharge Thermistor Error	17
7 2	Compressor Thermistor Error	18
7 3	Heat Ex. Liquid Outlet Thermistor Error	19
7 4	Outdoor Thermistor Error	20
7 5	Suction Gas Thermistor Error	21
7 7	Heat Sink Thermistor Error	22

Error Code	Error Contents	Trouble shooting
8 2	Sub-Cool Heat Ex.Gas Inlet Thermistor Error Sub-Cool Heat Ex.Gas Outlet Thermistor Error	23, 24
8 3	Liquid Pipe Thermistor Error	25
8 4	Current Sensor Error	26
8 6	Discharge Pressure Sensor Error Suction Pressure Sensor Error High Pressure Switch Error	27,28,29
9 4	Over Current Error	30
9 5	Compressor Control Error	31
9 7	Outdoor Unit Fan Motor Error	32
9 9	4 Way Valve Error	33
A 1	Discharge Temp. Error	34
A 3	Compressor Temp. Error	35
A 5	Low Pressure Error	36
J 2	Branch Box Error	1,40 ~ 45

2-3-4 Outdoor Unit Display

LED display

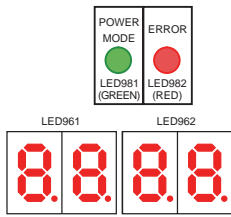

POWER MODE LED : on
ERROR LED : flashing

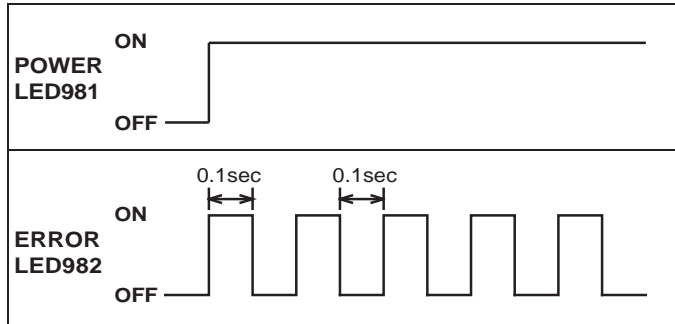







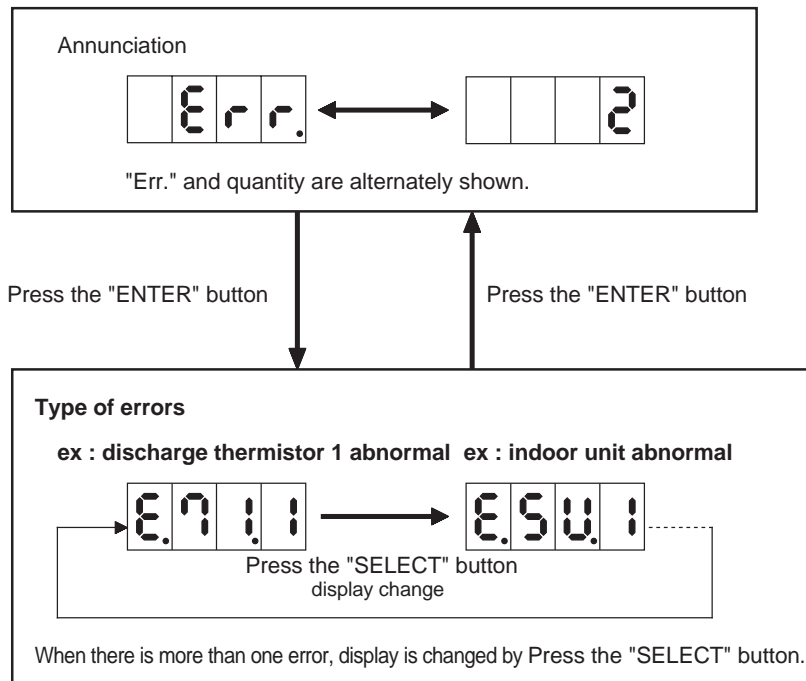







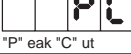

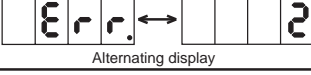



Operation button

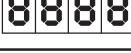

ERROR transition

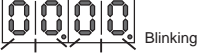

If some error is newly occurred or resolved during transition, it is reflected after going back to "Annunciation".

Indication type	7 Segment LED Pattern	Description
Idling(stop)	 Blank	
Cooling mode	 "C" "OO" "L"	During Cooling mode
Heating mode	 "H" "EA" "T"	During Heating mode
Oil recovery operation	 "O" "IL" "R" "ECOVERY"	During Oil recovery operation. Refer to 01-25 page for operation.
Defrost operation	 "D" "E" "F" "ROST"	During Defrost operation. Refer to 01-22 page for operation.
Power saving operation	 "P" "eak" "C" "ut"	During Power saving operation. Refer to 01-29 page for operation.
Low noise operation	 "L" "OW" "N" "OISE"	During Low noise operation. Refer to 01-29 page for operation.
Error display mode (Number of errors occurred)	ex.  Alternating display	Number of errors occurred are displayed. (Ex. Two error codes present.) Refer to 02-11 page for details.
Error display mode (Error code)	ex. 	Error codes are displayed. (Ex. Discharge thermistor error) Refer to 02-11 page for details.
Running the vacuum/ pump down mode	 "RUN"	Vacuum/ Pump down mode running.
End of the function	 "DONE"	The function is finished normally. (Function is "Test-run start/ stop" and "EEPROM memory clear".)
Performing function failed	 "FAIL"	The function can not be performed.
Power off	 "P" "OWER" "OFF"	When "P.oFF" is displayed, turn off the power supplies of all units.
Preparation display		Number of "8888" is displayed for 2 minutes after power on.
Connected units display (Only for Check run)	ex. 	
Running Check.	 "C" "HECK" "RUN"	Wiring check in Check run is performing.
End of Check run	 "END"	Check run is finished.
Memory clear	 Blinking	Number "0000" is blinking for 1 minute when the memory is cleared after Check run is finished.
Error display for Check run (Wiring number error)	 "P" "IPE" ">" "L" "INE"	Number of wirings between indoor unit and branch box is not correct.
Error display for Check run (Pipe number error)	 "P" "IPE" "<" "L" "INE"	Number of pipes between indoor unit and branch box is not correct.
Error display for Check run (Wiring error)	ex. 	Wiring error has occurred. (Ex. Connection of Terminal A on the primary BB to Terminal B on secondary 2 BB is wrong.)
Indeterminable	 Blinking	The external or room temperature is outside the operating range of Check run.

2-3-5 Error Code List for Outdoor Unit Display

Error Code	Error Contents	Trouble shooting
E. 1 1. 3	Serial communication error	1, 37 ~ 39
E. 1 1. 4	Serial communication error	1, 37 ~ 39
E. 1 5. 6	Check run unfinished	3
E. 2 1. 2	Number of wires and pipes error	
E. 2 2. 1	Indoor unit capacity error	4
E. 2 4. 2	Number of indoor units error	6
E. 2 4. 3	Number of Branch boxes error	7
E. 5 U. 1	Indoor Unit error	8 ~ 13
E. 6 2. 1	Outdoor unit model information error	14
E. 6 3. 1	Inverter error	15
E. 6 4. 1	A.F. voltage error	16
E. 7 1. 1	Discharge thermistor error	17
E. 7 2. 1	Compressor thermistor error	18
E. 7 3. 3	Heat Ex. Liquid outlet thermistor error	19
E. 7 4. 1	Outdoor thermistor error	20
E. 7 5. 1	Suction gas thermistor error	21
E. 7 7. 1	Heat sink thermistor error	22

Error Code	Error Contents	Trouble shooting
E. 8 2. 1	Sub cool heat EX. gas inlet thermistor error	23
E. 8 2. 2	Sub cool heat EX. gas outlet thermistor error□	24
E. 8 3. 1	Liquid pipe thermistor error	25
E. 8 4. 1	Current sensor error	26
E. 8 6. 1	Discharge pressure sensor error	27
E. 8 6. 3	Suction pressure sensor error	28
E. 8 6. 4	High pressure switch error	29
E. 9 4. 1	Over current error	30
E. 9 5. 1	Compressor control error	31
E. 9 7. 3	Outdoor unit fan motor error	32
E. 9 9. 1	4-way valve error	33
E. A 1. 1	Discharge temp. error	34
E. A 3. 1	Compressor temp. error	35
E. A 5. 1	Low pressure error	36
E. J 2. U	Branch box error	1,40 ~ 45

2-3-6 Error status for Branch Box Display

When an error occurs, an error description displays in the LED (No.401 - 405).

●	Lit
◎(n)	Flashing (number of flashing)
○	Unlit

Green	Red				Comment	Trouble shooting
	LED401	LED402	LED403	LED404		
●	●	●	●	●	Connected combination error	37
●	●	●	●	○	Power frequency error	38
●	●	●	○	●		39
Branch box identifying display	◎(1)	○	○	○	EEPROM access error	40
	◎(2)	○	○	○	Model information error	41
	◎(3)	○	○	○	Serial communication error between Outdoor Unit and branch box	1
					Serial communication error between branch boxes	1
	◎(4)	○	○	○	Serial communication error between branch boxes	1
Primary unit : ◎(1)	◎(5)	●	○	○	Serial communication error between Indoor Unit A and branch box	1
		○	●	○	Serial communication error between Indoor Unit B and branch box	1
		○	○	●	Serial communication error between Indoor Unit C and branch box	1
Secondary unit1 : ◎(2)	◎(6)	●	○	○	Indoor Unit A, liquid pipe thermistor error (CN309)	42
		○	●	○	Indoor Unit B, liquid pipe thermistor error (CN309)	
		○	○	●	Indoor Unit C, liquid pipe thermistor error (CN310)	
Secondary unit2 : ◎(3)	◎(7)	●	○	○	Indoor Unit A, gas pipe thermistor error (CN309)	43
		○	●	○	Indoor Unit B, gas pipe thermistor error (CN309)	
		○	○	●	Indoor Unit C, gas pipe thermistor error (CN310)	
◎(8)	○	○	○	●	Indoor Unit A, EEV control error (CN305)	44
				●	Indoor Unit B, EEV control error (CN306)	
				●	Indoor Unit C, EEV control error (CN307)	
◎(9)	○	○	○	○	Remote controller communication error	45

Error Indication Flashing Pattern

Example : "Serial communication error between Indoor Unit B and branch box" at Secondary unit1
 (LED401: 2times, LED402: 5times, LED403: Unlit, LED404: Lit, LED405: Unlit)

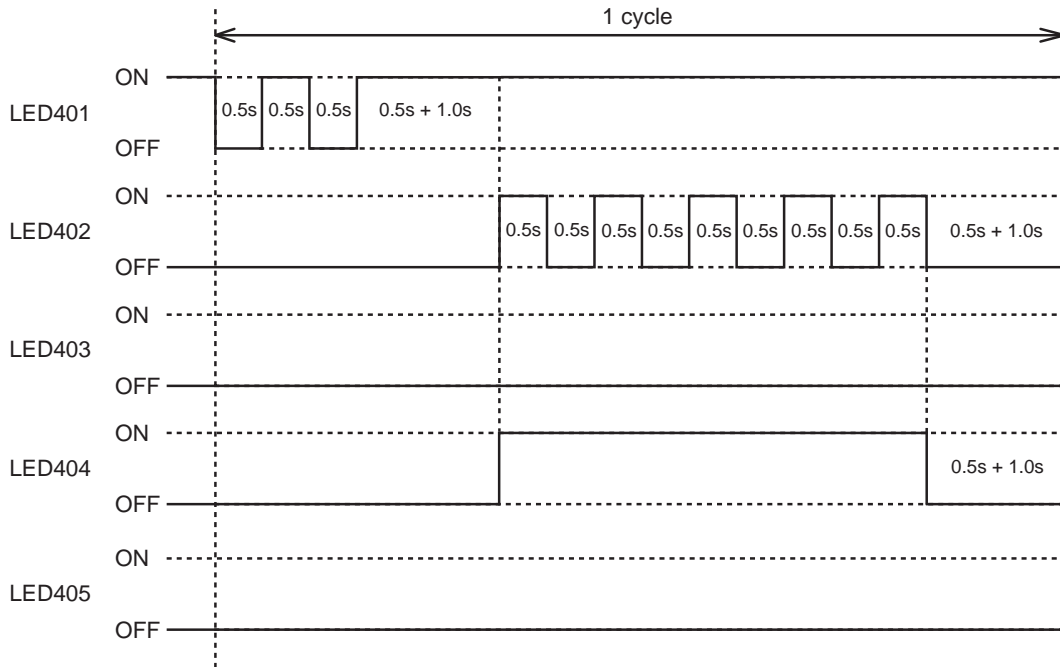

2-4 TROUBLE SHOOTING

<p>Trouble shooting 1 ALL UNIT Error Method: Serial Communication Error (Serial Forward / Reverse Transfer Error)</p>	<p>Indicate or Display: Outdoor Unit : Indoor Unit : Refer to Connection line and Serial signal error list Error Code : (Page 13)</p>
<p>Detective Actuators:</p> <p>Outdoor Unit Indoor Unit Branch Box (Primary / secondary)</p>	<p>Detective details:</p> <ul style="list-style-type: none"> · When the branch box cannot properly receive the serial signal from Outdoor unit / Indoor unit / Branch Box. · When the Outdoor unit / Indoor unit cannot properly receive the serial signal from Branch Box. <ul style="list-style-type: none"> - When power is turn-on : 2 minutes. - In operation : 15 seconds.

Forecast of Cause:

1. Connection failure
2. External cause
3. Main PCB(Outdoor unit) failure
4. Controller PCB(Indoor unit / Branch Box) failure

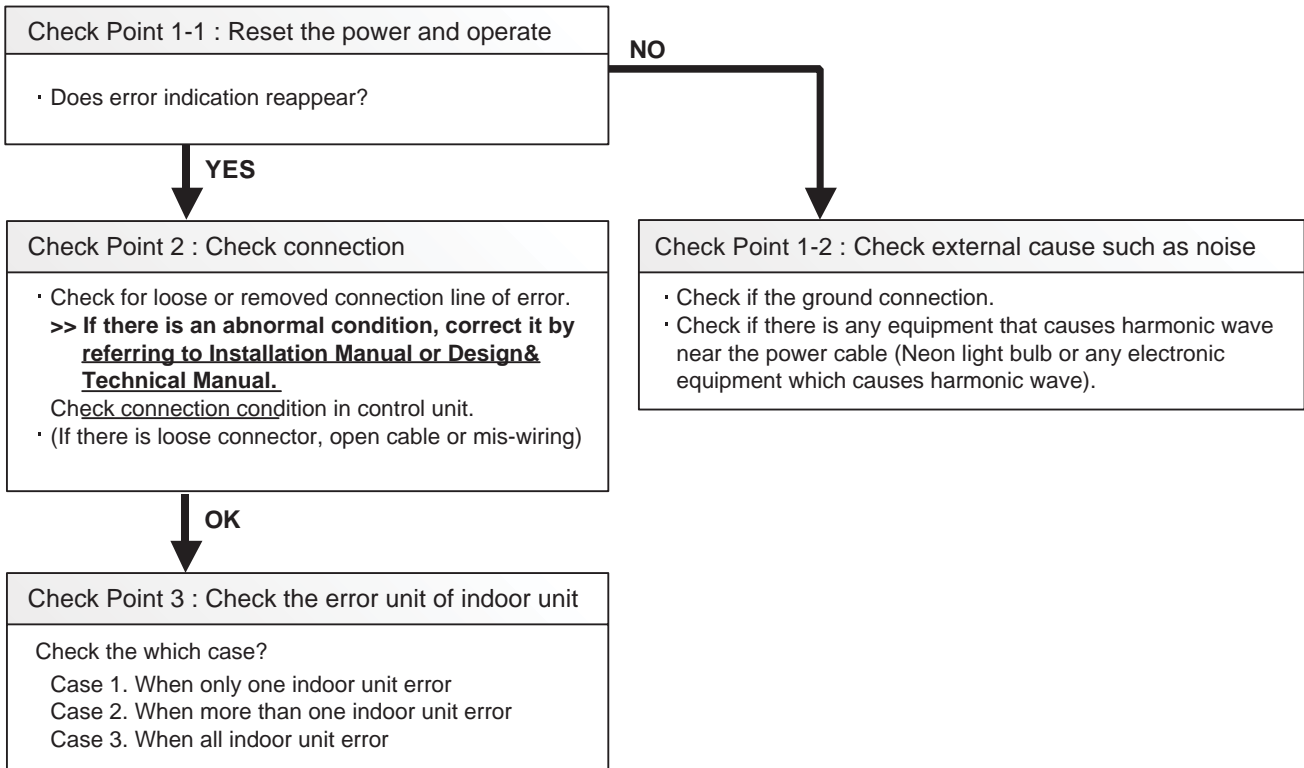

Case 1. When only one indoor unit error

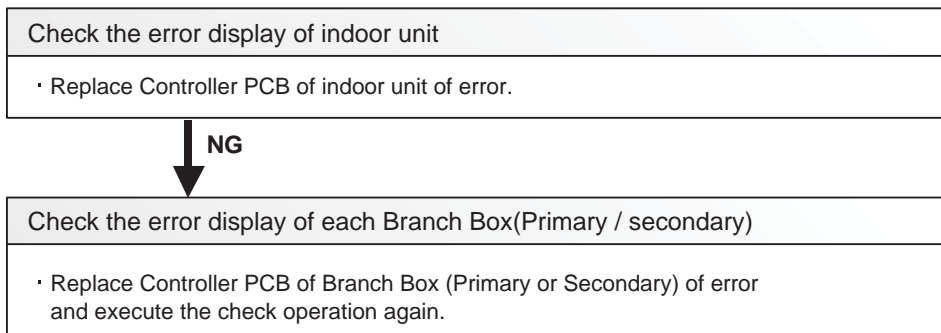

Case 2. When more than one indoor unit error (2unit or 3 unit)

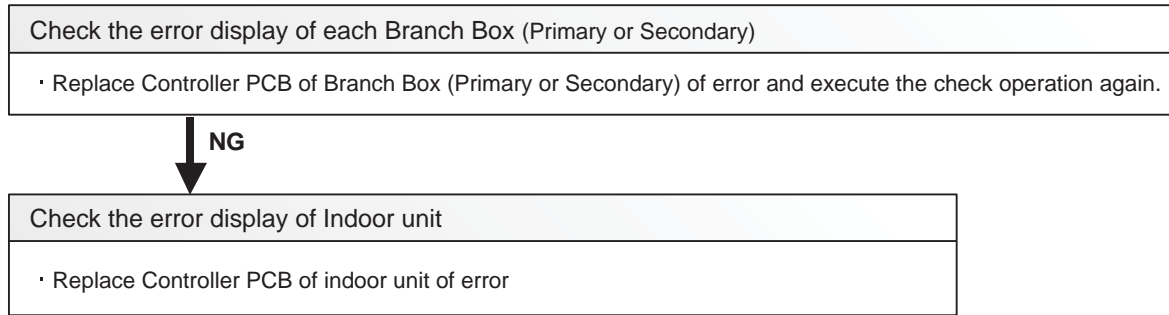

Case 3. When all indoor unit error

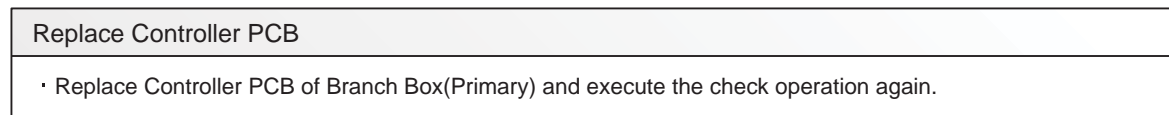

NG

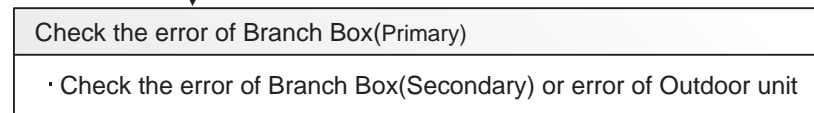

When Outdoor unit error

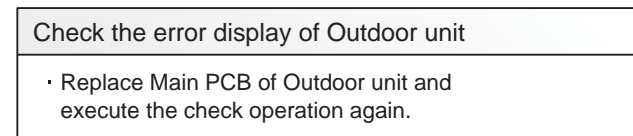

NG

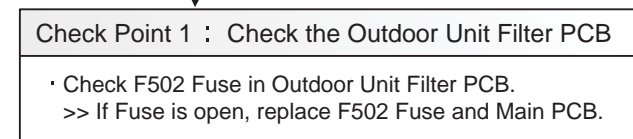

When Branch Box(Secondary) error

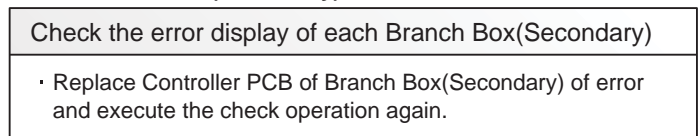

When there is no LED display of outdoor unit

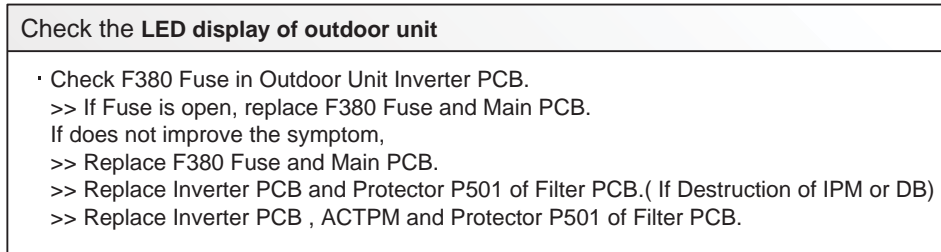

Connection Line (example)

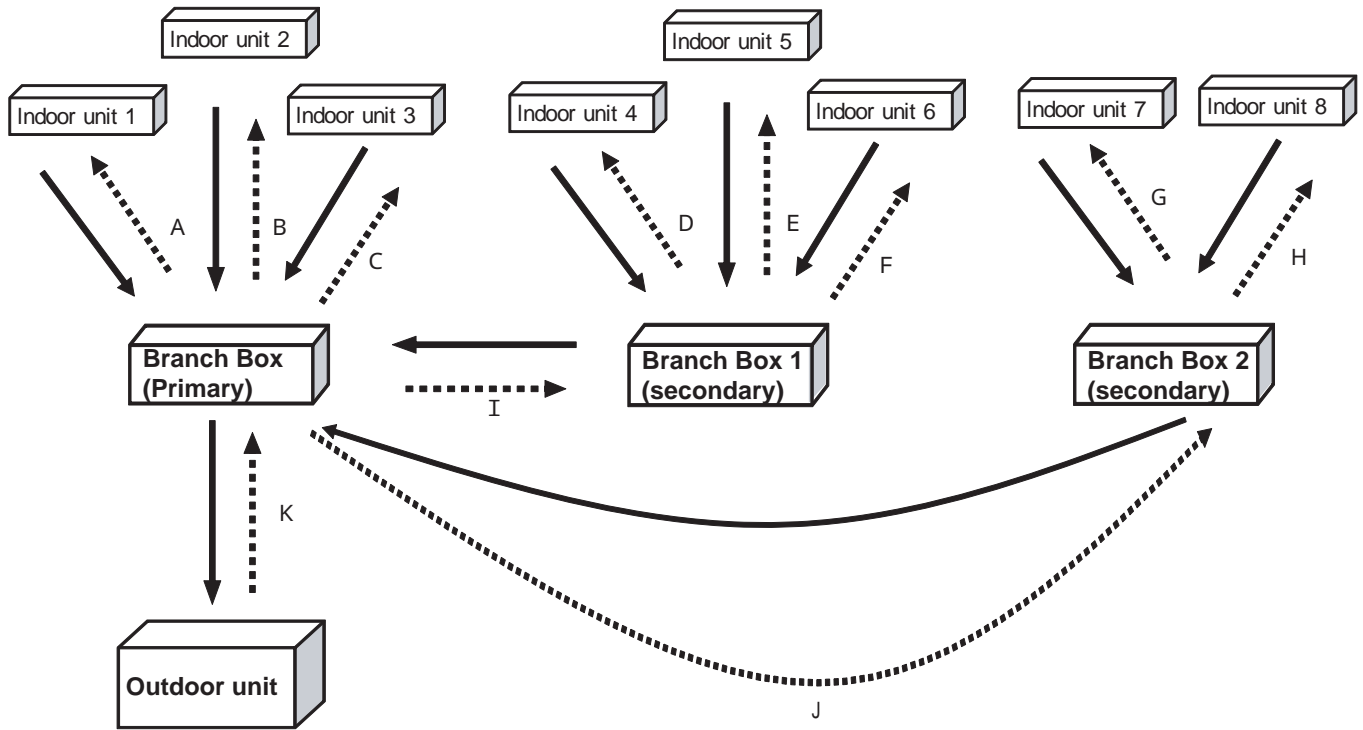

~ Serial Forward Transfer Error
 A ~ K Serial Reverse Transfer Error

Serial signal error list

	Indoor unit 1		Indoor unit 2		Indoor unit 3		Indoor unit 4		Indoor unit 5		Indoor unit 6		Indoor unit 7		Indoor unit 8		Branch Box(Primary)					Branch Box 1(secondary)					Branch Box 2(secondary)					Outdoor unit								
	1st	2nd	3rd	1st	2nd	3rd	1st	2nd	3rd	1st	2nd	3rd	1st	2nd	3rd	1st	2nd	3rd	LED401	LED402	LED403	LED404	LED405	LED401	LED402	LED403	LED404	LED405	LED401	LED402	LED403	LED404	LED405	LED961	LED962					
Serial Forward Transfer Error																		(1)	(5)															E	J	2	U			
																			(1)	(5)															E	J	2	U		
																			(1)	(5)																E	J	2	U	
																							(2)	(5)												E	J	2	U	
																							(2)	(5)												E	J	2	U	
																								(2)	(5)											E	J	2	U	
																													(3)	(5)							E	J	2	U
																												(3)	(5)								E	J	2	U
																				(1)	(4)			(2)	(4)											E	J	2	U	
Serial Reverse Transfer Error	A																		(1)	(5)															E	5	U	1		
	B																		(1)	(5)															E	5	U	1		
	C																		(1)	(5)															E	5	U	1		
	D																						(2)	(5)											E	5	U	1		
	E																						(2)	(5)											E	5	U	1		
	F																						(2)	(5)											E	5	U	1		
	G																											(3)	(5)						E	5	U	1		
	H																											(3)	(5)						E	5	U	1		
	I																							(3)																
	J																											(3)												
																												(3)	(4)	x				E	J	2	U			
	K																			(3)			(3)					(3)					E	1	1	3				
																				(1)	(3)													E	J	2	U			

LED Display pattern of Indoor unit
 • 1st - Operation LED • ○ Number of flashes (0.5sec)
 • 2nd - Timer LED • ⊙ Continuous flash
 • 3rd - Economy LED • - No display

LED Display pattern of Branch Box
 • (n) - Flashing(number of flashing)
 • - Lit
 • - Unlit

Trouble shooting 2 INDOOR UNIT Error Method: Wired Remote Controller Communication Error	Indicate or Display: Outdoor Unit : E.5 U.1 Indoor Unit : Operation LED 1 times Flash, Timer LED 2 Times Flash, Economy LED Continuous Flash. Error Code : 1 2
---	---

Detective Actuators: Indoor unit controller PCB Wired Remote Controller	Detective details: Upon receiving the signal more than 1 time from Wired Remote or other Indoor unit, but the same signal has not been received more than 1 minute.
--	---

Forecast of Cause : 1. Terminal connection abnormal 2. Wired Remote Controller failure 3. Controller PCB failure

Check Point 1 : Check the connection of terminal

After turning off the power, check & correct the followings.

- Indoor Unit - Check the connection of terminal between remote controller and Indoor unit, and check if there is a disconnection or short of the cable.



Check Point 2 : Check Remote controller and Controller PCB

- Check terminal voltage of controller PCB Connector. (Power supply for Remote)
 Cassette / Duct Type ⇒ CN14 , Wall mount Type ⇒ CN6 , Small size Wall mount Type ⇒ CN305(UTY-XCBXZ14)
 If DC12V, Remote Controller failure (Controller PCB is OK) >>> Replace Remote Controller
 If DC0V, Controller PCB failure (Remote is OK) >>> Replace Controller PCB and execute the check operation again.

▶ **In case of re-installation is done due to removed connector or incorrect wiring, turn on the power again.**



Trouble shooting 3 <u>INDOOR UNIT Error Method:</u> Check run unfinished	<u>Indicate or Display:</u> Outdoor Unit : E. 15. 6 Indoor Unit : Operation LED 1 times Flash, Timer LED 5 Times Flash, Economy LED Continuous Flash. Error Code : 15
---	--

<u>Detective Actuators:</u> Outdoor unit Branch BOX	<u>Detective details:</u> When the operation command is input by remote controller without check operation completion.
--	--

<u>Forecast of Cause :</u> 1. Check operation not complete 2. Outdoor Main PCB changed 3. Branch BOX PCB changed
--

Check Point 1 : Check the indoor unit number connection
<ul style="list-style-type: none"> · Check the number of indoor unit connected. >> <u>If the check operation not complete, execute it by referring to Installation Manual or Design & Technical Manual.</u> >> <u>Upon correcting incorrect setting, reset the power.</u>



Check Point 2 : Replace Main PCB
<ul style="list-style-type: none"> · <u>Replace Main PCB, and execute the check operation again.</u>

<u>INDOOR UNIT Error Method:</u> Number of Wires and Pipes Error	<u>Indicate or Display:</u> Outdoor Unit : E.2 1.2 Indoor Unit : Operation LED 2 times Flash, Timer LED 1 Times Flash, Economy LED Continuous Flash. Error Code : 2 1
---	--

<u>Detective Actuators:</u> Indoor unit	<u>Detective details:</u> When the operation command is input by remote controller without check operation completion. When a PCB has been replaced.
---	---

<u>Forecast of Cause :</u> 1. Check operation not complete 2. Indoor Controller PCB changed 3. Branch BOX PCB changed

Check Point 1 : Check the indoor unit number connection
<ul style="list-style-type: none"> · Check the number of indoor unit connected. >> <u>If the check operation not complete, execute it by referring to Installation Manual or Design & Technical Manual.</u> >> <u>Upon correcting incorrect setting, reset the power.</u>



Check Point 2 : Replace Controller PCB
<ul style="list-style-type: none"> · <u>Replace Controller PCB, and execute the check operation again.</u>

Trouble shooting 4 <u>INDOOR UNIT Error Method:</u> Indoor Unit Capacity Error	<u>Indicate or Display:</u> Outdoor Unit : E. 22. 1 Indoor Unit : Operation LED 2 times Flash, Timer LED 2 Times Flash, Economy LED Continuous Flash. Error Code : 22
---	--

<u>Detective Actuators:</u> All indoor unit	<u>Detective details:</u> When the total capacity of indoor units is outside of range between 38,000BTU and 63,000BTU.
---	--

<u>Forecast of Cause :</u> 1. The selection of indoor units is incorrect 2. Main PCB(Outdoor unit) failure

Check Point 1 : Check the total capacity of indoor unit
· Check the total capacity of the connected indoor units. >> <u>If abnormal condition is found, correct it by referring to Installation Manual or Design & Technical Manual.</u>



Check Point 2 : Replace Main PCB
▶ <u>If Check Point 1 do not improve the symptom, replace Main PCB(Outdoor unit), and execute the check operation again.</u>

<p>Trouble shooting 5 <u>INDOOR UNIT Error Method:</u> Connected Combination Error</p>	<p>Indicate or Display: Outdoor Unit : E.5 U.1 or E.J 2.U Indoor Unit : Operation LED 2 times Flash, Timer LED 3 Times Flash, Economy LED Continuous Flash. Error Code : 2 3</p>
---	---

<p><u>Detective Actuators:</u></p> <p>Indoor Unit Branch Box</p>	<p><u>Detective details:</u></p> <p>When power is on and one of the below occurs.</p> <ol style="list-style-type: none"> 1. When the wiring is mistake 2. When the connection outdoor unit different. 3. When the connection indoor unit of unsupported multi.
--	--

<p><u>Forecast of Cause:</u></p> <ol style="list-style-type: none"> 1. connections condition in Controller PCB(Indoor unit / Branch Box)
--

<p>Check Point 1 : Check the Indoor unit / Branch Box</p>
<p><input type="checkbox"/> Check the Indoor unit / Branch Box</p> <p>>> <u>If there is abnormal connect, correct it by referring to Installation Manual or Design & Technical Manual.</u></p> <p>>> <u>Upon correcting incorrect setting, and execute the check operation again.</u></p>

<p>Trouble shooting 6 <u>INDOOR UNIT Error Method:</u> Number of Indoor Units Error</p>	<p><u>Indicate or Display:</u> Outdoor Unit : E. 24. 2 Indoor Unit : Operation LED 2 times Flash, Timer LED 4 Times Flash, Economy LED Continuous Flash. Error Code : 24</p>
--	---

<p><u>Detective Actuators:</u> Indoor Unit</p>	<p><u>Detective details:</u> When the total connection number of indoor units is outside of range between 2 and 8.</p>
--	--

<p><u>Forecast of Cause :</u> 1. Indoor unit connection failure</p>

<p>Check Point 1 : Check the indoor unit number connection</p>
<ul style="list-style-type: none"> · Check the indoor unit number connection. >> <u>If there is an abnormal condition, correct it by referring to Installation Manual or Design & Technical Manual.</u> >> <u>Upon correcting incorrect setting, reset the power.</u>

<p>Trouble shooting 7 <u>Branch Box Error Method:</u> Number of Branch Boxes Error</p>	<p><u>Indicate or Display:</u> Outdoor Unit : E. 24. 3 Indoor Unit : Operation LED 2 times Flash, Timer LED 4 Times Flash, Economy LED Continuous Flash. Error Code : 24</p>
---	---

<p><u>Detective Actuators:</u> Branch Box</p>	<p><u>Detective details:</u> When the number of branch boxes ① and ② are different, and the operation command is input to the outdoor unit.</p> <p>① Memorized number at the check operation. ② Number of Serial forward signal.</p>
---	---

<p><u>Forecast of Cause :</u></p> <ol style="list-style-type: none"> 1. Branch box power failure 2. Branch box connection failure
--

<p>Check Point 1 : Check the Branch box power</p>
<ul style="list-style-type: none"> · Check the Branch Box power >> <u>If there is an abnormal condition, power turned on.</u>



<p>Check Point 2 : Check the Branch box connection</p>
<ul style="list-style-type: none"> · Check the Branch Box connection. >> <u>If there is an abnormal condition, correct it by referring to Installation Manual or Design & Technical Manual.</u> >> <u>Upon correcting incorrect setting, reset the power.</u>

Trouble shooting 8 INDOOR UNIT Error Method: Indoor Unit Model Information Error EEPROM Access Abnormal	Indicate or Display: Outdoor Unit : E.5 U.1 Indoor Unit : Operation LED 3 times Flash, Timer LED 2 Times Flash, Economy LED Continuous Flash. Error Code : 3 2
--	---

Detective Actuators: Indoor Unit	Detective details: 3 continuous failure of read test of EEPROM at power on, or apparent model information error from EEPROM. Also, error on model information upon model information test of EEPROM, or Model information of EEPROM not possible to recover.
--	--

Forecast of Cause : 1. External cause 2. connections condition in Controller PCB 3. Controller PCB failure

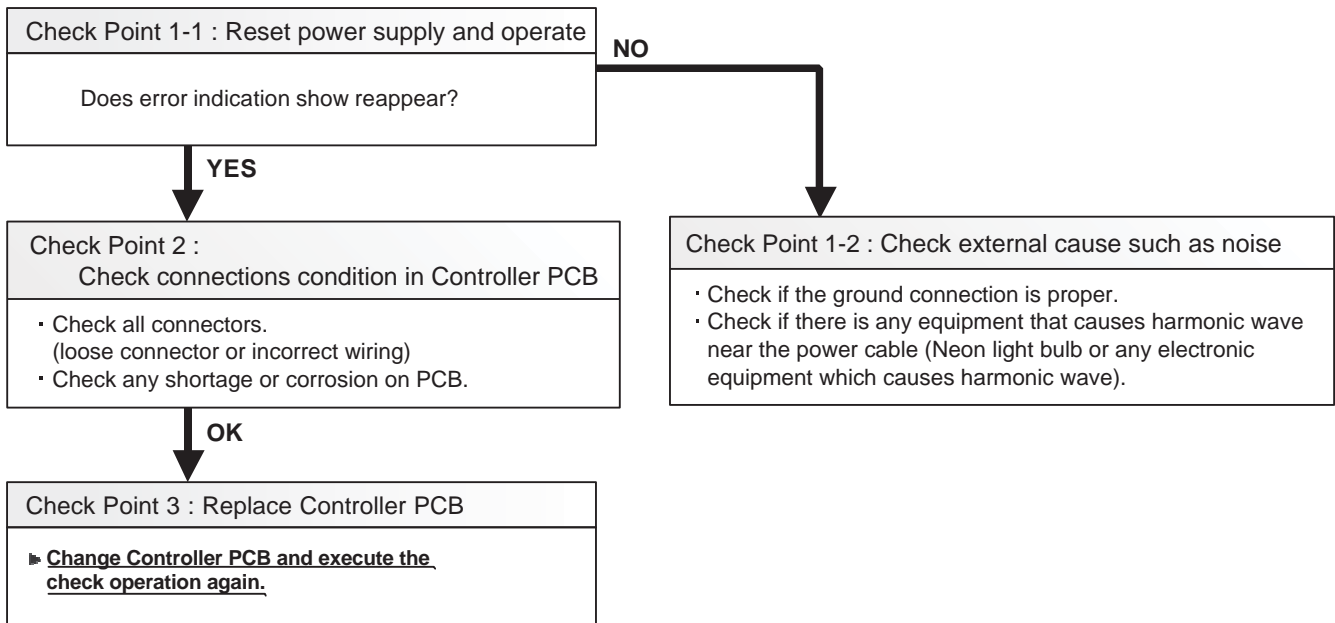

<p>Trouble shooting 9 <u>INDOOR UNIT Error Method:</u> Manual Auto Switch Error</p>	<p><u>Indicate or Display:</u> Outdoor Unit : No Display Indoor Unit : Operation LED 3 times Flash, Timer LED 2 Times Flash, Economy LED Continuous Flash. Error Code : 3 5</p>
--	--

<p><u>Detective Actuators:</u> Indoor Unit Controller PCB Indicator PCB Manual Auto Switch</p>	<p><u>Detective details:</u> When the Manual Auto Switch becomes ON for consecutive 30 or more seconds.</p>
--	---

Forecast of Cause :
1. Manual Auto Switch failure 2. Controller PCB and Indicator PCB failure

<p>Check Point 1 : Check the Manual Auto Switch</p>	
<ul style="list-style-type: none"> · Check if Manual Auto Switch is kept pressed. · Check ON/OFF switching operation by using a meter. >> <u>If Manual Auto Switch is disabled (on/off switching), replace it.</u> 	



<p>Check Point 2 : Replace Controller PCB and Indicator PCB</p>
<p>▶ <u>If Check Point 1 do not improve the symptom, replace Controller PCB and Indicator PCB and execute the check operation again.</u></p>

Trouble shooting 10 INDOOR UNIT Error Method: Indoor Room Thermistor Error	Indicate or Display: Outdoor Unit : E.5 U.1 Indoor Unit : Operation LED 4 times Flash, Timer LED 1 Times Flash, Economy LED Continuous Flash. Error Code : 4 1
---	---

Detective Actuators: Indoor Unit Controller PCB Circuit Indoor Temperature Thermistor	Detective details: Indoor unit thermistor is open or short is detected always.
--	--

Forecast of Cause : 1. Connector failure connection 2. Thermistor failure 3. Controller PCB failuer

Check Point 1 : Check connection of Connector

- Check if connector is loose or removed
- Check erroneous connection
- Check if thermistor cable is open

>>Reset Power when reinstalling due to removed connector or incorrect wiring.



Check Point 2 : Remove connector and check Thermistor resistance value

Thermistor Characteristics (Rough value)

Temperature (°F)	32	41	50	59	68	77	86	95
Resistance Value (kΩ)	33.6	25.2	20.1	15.8	12.5	10.0	8.0	6.5

Temperature (°F)	104	113	122
Resistance Value (kΩ)	5.3	4.3	3.5

▶ **If Thermistor is either open or shorted, replace it and reset the power.**



Check Point 3 : Check voltage of Controller PCB (DC5.0V)

Make sure circuit diagram of each indoor unit and check terminal voltage at Thermistor (DC5.0V)

- Duct circuit diagram (Connector connection)
- Small size Wall mount circuit diagram(Connector connection)
- Cassette circuit diagram (Connector connection)
- Wall mount Scircuit diagram (Direct soldering to PCB)

Duct circuit diagram (Connector connection)

Small size Wall mount circuit diagram(Connector connection)

Cassette circuit diagram (Connector connection)

Wall mount Scircuit diagram (Direct soldering to PCB)

▶ **If the voltage does not appear, replace Controller PCB and execute the check operation again.**

Trouble shooting 11 INDOOR UNIT Error Method: Indoor Heat Ex. Thermistor Error	Indicate or Display: Outdoor Unit : E.5 U.1 Indoor Unit : Operation LED 4 times Flash, Timer LED 2 Times Flash, Economy LED Continuous Flash. Error Code : 4 2
---	---

Detective Actuators: Indoor Unit Controller PCB Heat Exchanger (MID) Thermistor	Detective details: Indoor unit thermistor is open or short is detected always.
--	--

Forecast of Cause : 1. Connector failure connection 2. Thermistor failure 3. Controller PCB failuer

Check Point 1 : Check connection of Connector

- Check if connector is loose or removed
- Check erroneous connection
- Check if thermistor cable is open

>>Reset Power when reinstalling due to removed connector or incorrect wiring.



Check Point 2 : Remove connector and check Thermistor resistance value

Thermistor Characteristics (Rough value)

Temperature (°F)	32	41	50	59	68	77	86	95
Resistance Value (kΩ)	168.6	129.8	100.9	79.1	62.5	49.8	40.0	32.4

Temperature (°F)	104	113	122
Resistance Value (kΩ)	26.3	21.2	17.8

► If Thermistor is either open or shorted, replace it and reset the power.



Check Point 3 : Check voltage of Controller PCB (DC5.0V)

Make sure circuit diagram of each indoor unit and check terminal voltage at Thermistor (DC5.0V)

• Duct circuit diagram (Connector connection)

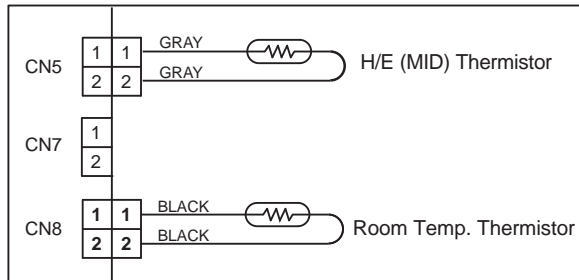

• Small size Wall mount circuit diagram(Connector connection)

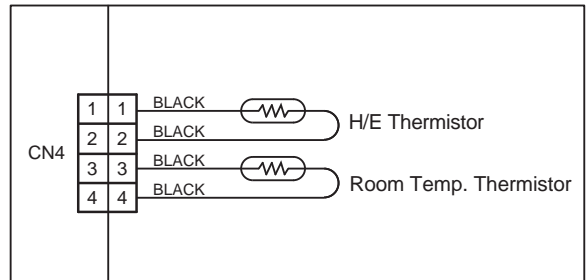

• Cassette circuit diagram (Connector connection)

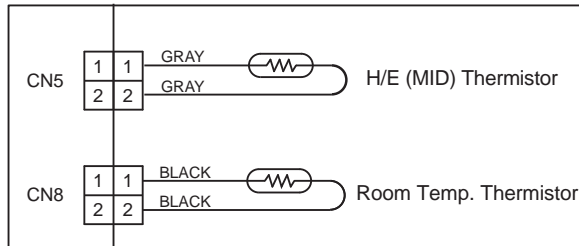

• Wall mount circuit diagram (Direct soldering to PCB)

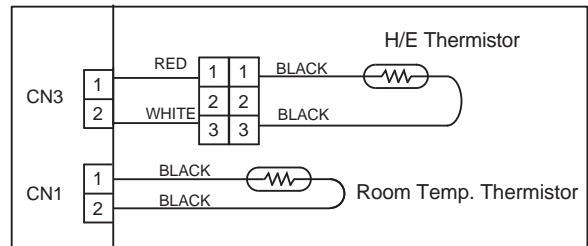

► If the voltage does not appear, replace Controller PCB and execute the check operation again.

Trouble shooting 12 INDOOR UNIT Error Method: Indoor Unit Fan Motor Error	Indicate or Display: Outdoor Unit : E.5 U.1 Indoor Unit : Operation LED 5 times Flash, Timer LED 1 Times Flash, Economy LED Continuous Flash. Error Code : 5 1
--	---

Detective Actuators: Indoor Unit Controller PCB Indoor Fan Motor	Detective details: When Indoor fan control is either phase control or DC control and rotation feed back control is ON, the feed back rotation value becomes 0 and lasts for more than 1 minute at motor operation condition. Or, the feed back rotation value continues at 1/3 of target value for more than 1 minute.
---	--

Forecast of Cause : 1. Fan MOTOR failure 2. Fan motor winding open 3. Motor protection by surrounding temp. increase
4. Controller PCB failure

Check Point 1 : Check rotation of Fan

Rotate the fan by hand when operation is off.
(Check if fan is caught, dropped off or locked motor)
>>If Fan or Bearing is abnormal, replace it.



Check Point 2 : Check Motor winding

Check Indoor Fan motor
>>If Fan motor is abnormal, replace it.



Check Point 3 : Check ambient temp. around motor

Check excessively high temperature around the motor.
(If there is any surrounding equipment that causes heat)
>>Upon the temperature coming down, restart operation.



Check Point 4 : Replace Controller PCB

Change Controller PCB and execute the check operation again.

Trouble shooting 13 INDOOR UNIT Error Method: Drainage Error	Indicate or Display: Outdoor Unit : E.5 U.1 Indoor Unit : Operation LED 5 times Flash, Timer LED 3 Times Flash, Economy LED Continuous Flash. Error Code : 53
---	--

Detective Actuators: Indoor Unit Controller PCB Circuit Float Switch	Detective details: When Float switch is ON for more than 3 minutes.
---	---

Forecast of Cause : 1. Float switch failure 2. Shorted connector/wire 3. Controller PCB failure
 4. Drain pump failure 5. Hose clogging

Check Point 1 : Check Float Switch

- Check operation of float switch. (any blocking by dust, etc.)
- Remove Float switch and check ON/OFF switching operation by using a meter.
>>If Float switch is abnormal, replace it.

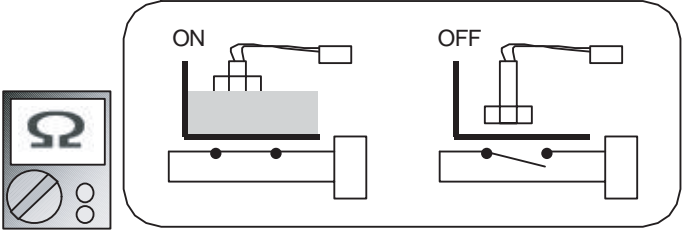

↓
OK

Check Point 2 : Check Connector (CN 9) / Wire

- Check loose contact of CN9 /shorted wire (pinched wire).
>>Replace Float switch if the wire is abnormal

↓
OK

Check Point 3 : Check Drain Hose

- Check Drain Hose .
>>If there is Hose clogging. Please clear the clog.

↓
OK

Check Point 4 : Check Controller PCB

If Check Point 1 ~ 3 do not improve the symptom, change Controller PCB and execute the check operation again.

Attention!!
 Wall mount / Small size wall mount type does not have a float switch.
 In this case, replace Controller PCB and set up the original address.
 Please refer to.

Trouble shooting 14 OUTDOOR UNIT Error Method: Outdoor Unit Model Information Error	Indicate or Display: Outdoor Unit : E. 62. 1 Indoor Unit : Operation LED 6 times Flash, Timer LED 2 Times Flash, Economy LED Continuous Flash. Error Code : 62
--	---

Detective Actuators: Outdoor unit Main PCB	Detective details: • Access to EEPROM failed due to some cause after outdoor unit started.
--	--

Forecast of Cause : 1. External cause (Noise, temporary open, voltage drop) 2. Main PCB failure

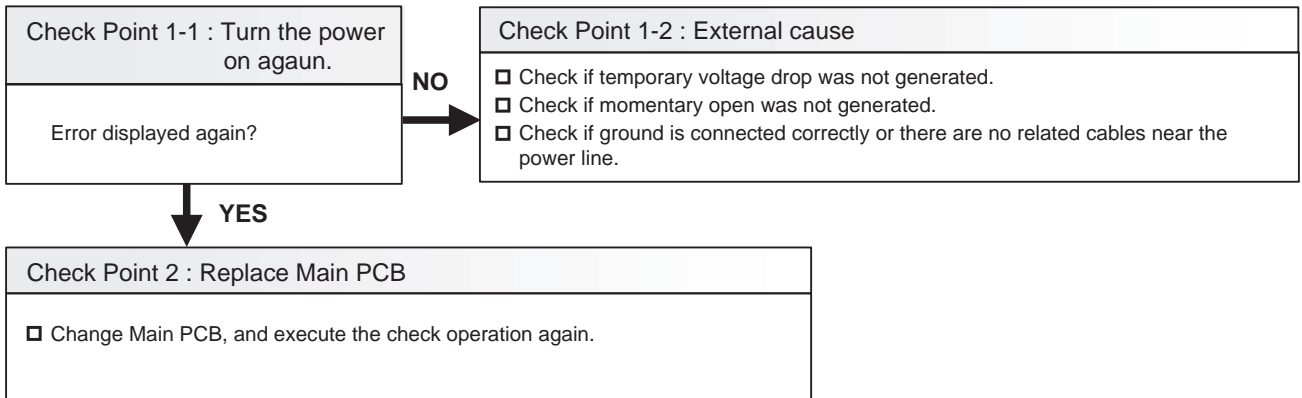

Trouble shooting 15 OUTDOOR UNIT Error Method: Inverter Error	Indicate or Display: Outdoor Unit : E. 63. 1 Indoor Unit : Operation LED 6 times Flash, Timer LED 3 Times Flash, Economy LED Continuous Flash. Error Code : 63
--	---

Detective Actuators: Inverter PCB Main PCB Filter PCB	Detective details: •Error information received from Inverter PCB
---	--

Forecast of Cause : <ol style="list-style-type: none"> 1. External cause 2. Power supply line & Communication line to Filter PCB to Inverter PCB wiring disconnection, open 3. Inverter PCB failure 4. Main PCB failure 5. Filter PCB failure

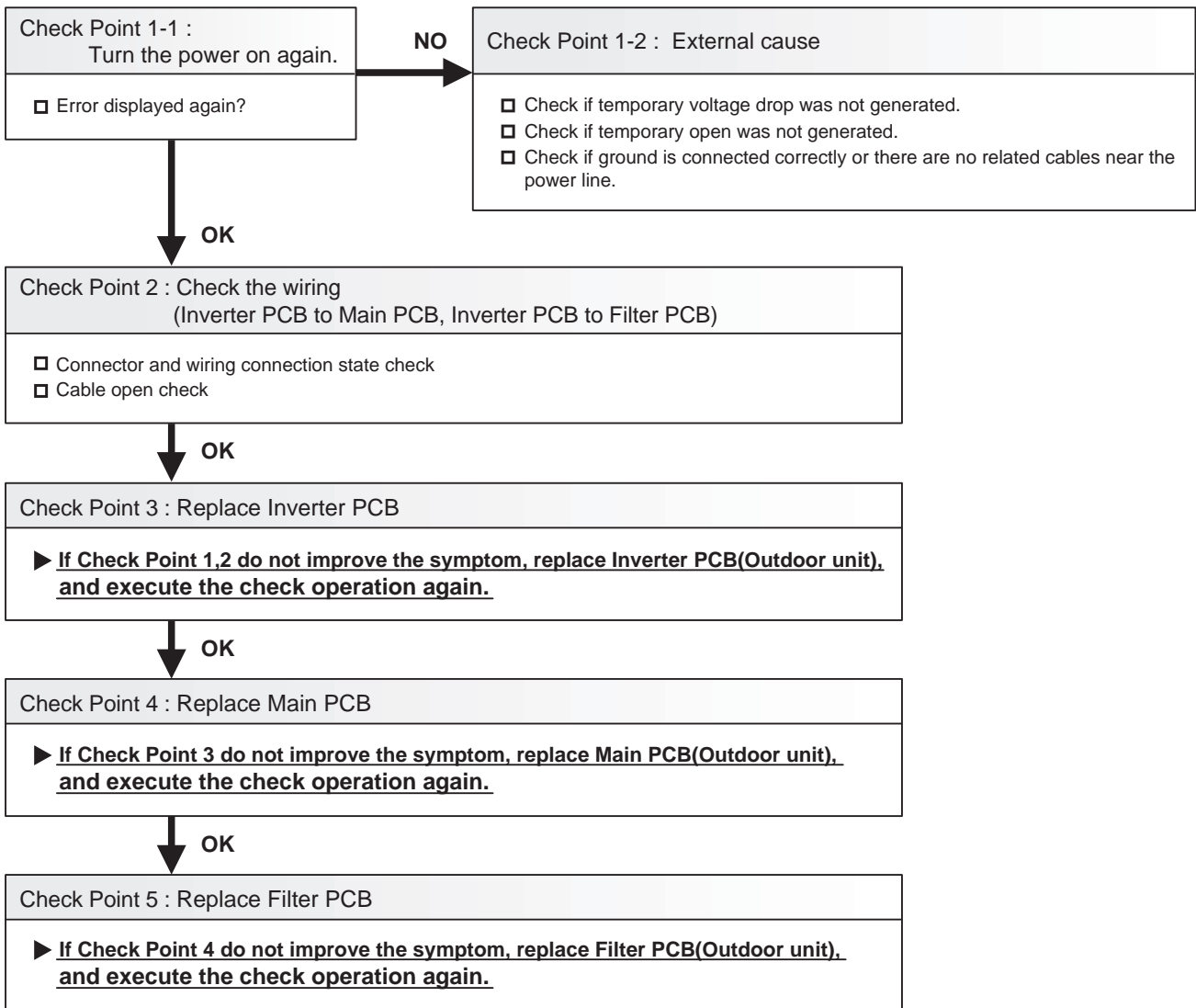

Trouble shooting 16 <u>OUTDOOR UNIT Error Method:</u> A.F Voltage Error	<u>Indicate or Display:</u> Outdoor Unit : E. 64. 1 Indoor Unit : Operation LED 6 times Flash, Timer LED 4 Times Flash Economy LED Continuous Flash. Error Code : 64
--	---

<u>Detective Actuators:</u> Outdoor Unit Main PCB Outdoor Unit ACTPM PCB	<u>Detective details:</u> <ul style="list-style-type: none"> • Inverter low voltage protection • Inverter overvoltage protection
---	--

Forecast of Cause :
 1. Connector connection failure 2. Inverter PCB failure 3. ACTPM failure

Check Point 1 : Check connections condition in control unit

- Check if the terminal connection is loose.
- Check if connector is removed.
- Check if connector is erroneous connection.
- Check if cable is open.

>> Upon correcting the removed connector or mis-wiring, reset the power.



Check Point 2 : Check ACTPM

- Check ACTPM (**PARTS INFORMATION 8**).

▶ If ACTPM is abnormal, replace it.



Check Point 3 : Replace Inverter PCB

▶ If Check Point 1,2 do not improve the symptom, replace Inverter PCB, and execute the check operation again.

Trouble shooting 17 OUTDOOR UNIT Error Method: Discharge Thermistor Error	Indicate or Display: Outdoor Unit : E. 71. 1 Indoor Unit : Operation LED 7 times Flash, Timer LED Times Flash, Economy LED Continuous Flash. Error Code : 71
--	---

Detective Actuators: Discharge temperature thermistor	Detective details: <ul style="list-style-type: none"> • Discharge temperature thermistor short detected • Discharge thermistor open detected
---	--

Forecast of Cause :

1. Connector connection failure, open
2. Thermistor failure
3. Main PCB failure

Check Point 1 : Check the connector connection and cable open

- Connector connection state check
- Cable open check

↓ OK

Check Point 2 : Check the thermistor

- Thermistor characteristics check (Disconnect the thermistor from the PCB and check.)
 * For the thermistor characteristics, refer to the "Service Parts Information 5".

↓ OK

Check Point 3 : Check voltage of Main PCB (DC5.0V)

- Main PCB (CN62:1-2) voltage value = 5V
Remove the thermistor from Main PCB, check the voltage.

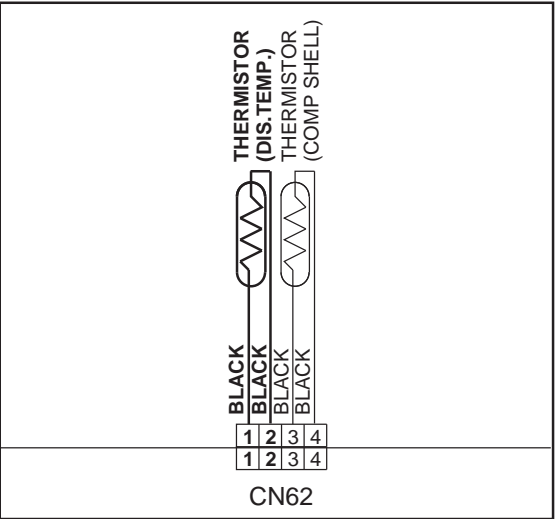

Discharge temperature thermistor (CN62:1-2)

► **If the voltage does not appear, replace Main PCB, and execute the check operation again.**

Trouble shooting 18 OUTDOOR UNIT Error Method: Compressor Thermistor Error	Indicate or Display: Outdoor Unit : E. 72. 1 Indoor Unit : Operation LED 7 times Flash, Timer LED 2 Times Flash, Economy LED Continuous Flash. Error Code : 72
---	---

Detective Actuators: Compressor temperature thermistor	Detective details: <ul style="list-style-type: none"> • Compressor temperature thermistor short detected • Compressor thermistor open detected
--	--

Forecast of Cause :

1. Connector connection failure, open
2. Thermistor failure
3. Main PCB failure

Check Point 1 : Check the connector connection and cable open

- Connector connection state check
- Cable open check

↓ **OK**

Check Point 2 : Check the thermistor

- Thermistor characteristics check (Disconnect the thermistor from the PCB and check.)
* For the thermistor characteristics, refer to the "Service Parts Information 14".

↓ **OK**

Check Point 3 : Check voltage of Main PCB (DC5.0V)

- Main PCB (CN62:3-4) voltage value = 5V
Remove the thermistor from Main PCB, check the voltage.

DC



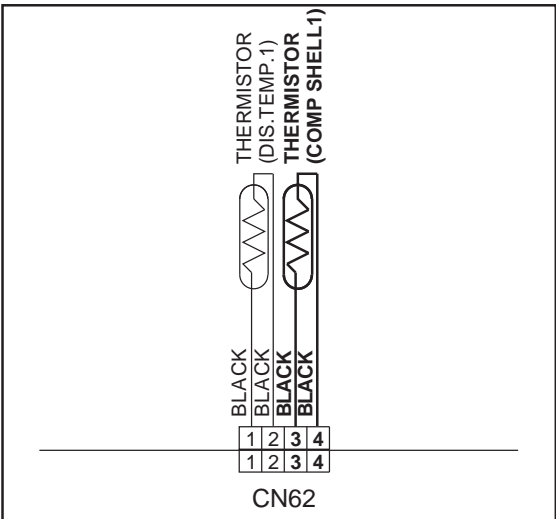

CN62

Compressor temperature thermistor (CN62:3-4)

▶ **If the voltage does not appear, replace Main PCB, and execute the check operation again.**

Trouble shooting 19 OUTDOOR UNIT Error Method: Heat Ex. Liquid Outlet Temp. Thermistor Error	Indicate or Display: Outdoor Unit : E. 73. 3 Indoor Unit : Operation LED 7 times Flash, Timer LED 3 Times Flash, Economy LED Continuous Flash. Error Code : 73
---	---

Detective Actuators: Heat exchanger liquid temperature thermistor	Detective details: • Heat exchanger outlet temperature thermistor short or open detected
---	--

Forecast of Cause :

1. Connector connection defective, open
2. Thermistor failure
3. Main PCB failure

Check Point 1 : Check the connector connection and cable open

- Connector connection state check
- Cable open check

↓ **OK**

Check Point 2 : Check the thermistor

- Thermistor characteristics check (Disconnect the thermistor from the PCB and check.)
* For the thermistor characteristics, refer to the "Service Parts Information 5".

↓ **OK**

Check Point 3 : Check voltage of Main PCB (DC5.0V)

- Main PCB (CN63:1-2) voltage value = 5V
Remove the thermistor from Main PCB, check the voltage.



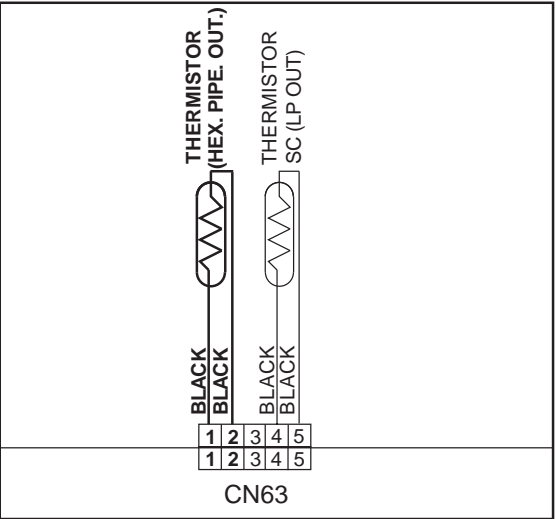

Heat exchanger outlet temperature thermistor (CN63:1-2)

▶ **If the voltage does not appear, replace Main PCB, and execute the check operation again.**

Trouble shooting 20 OUTDOOR UNIT Error Method: Outdoor Thermistor Error	Indicate or Display: Outdoor Unit : E. 74. 1 Indoor Unit : Operation LED 7 times Flash, Timer LED 4 Times Flash, Economy LED Continuous Flash. Error Code : 74
--	---

Detective Actuators: Outdoor temperature thermistor	Detective details: • Outdoor temperature thermistor short or open detected
---	--

Forecast of Cause : <ol style="list-style-type: none"> 1. Connector connection defective, open 2. Thermistor failure 3. Main PCB failure
--

Check Point 1 : Check the connector connection and cable open
<input type="checkbox"/> Connector connection state check <input type="checkbox"/> Cable open check

↓ **OK**

Check Point 2: Check the thermistor
<input type="checkbox"/> Thermistor characteristics check (Disconnect the thermistor from the PCB and check.) * For the thermistor characteristics, refer to the "Service Parts Information 5".

↓ **OK**

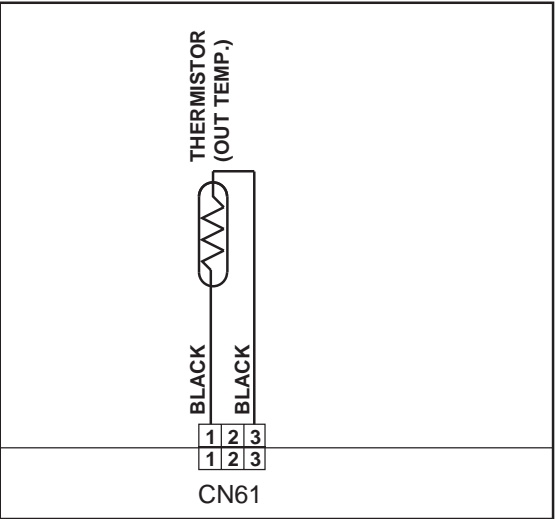
Check Point 3 : Check voltage of Main PCB (DC5.0V)	<div style="border: 1px solid black; padding: 5px; width: 40px; margin: 0 auto;"> DC  </div>
<input type="checkbox"/> Main PCB (CN61:1-3) voltage value = 5V <u>Remove the thermistor from Main PCB, check the voltage.</u>	
	
Outdoor temperature thermistor (CN61:1-3) ► <u>If the voltage does not appear, replace Main PCB, and execute the check operation again.</u>	

Trouble shooting 21
OUTDOOR UNIT Error Method:
Suction Gas Thermistor Error

Indicate or Display:
Outdoor Unit : E. 75. 1
Indoor Unit : Operation LED 7 times Flash, Timer LED 5 Times Flash, Economy LED Continuous Flash.
Error Code : 75

Detective Actuators:

Suction gas temperature thermistor

Detective details:

- Suction gas temperature thermistor short or open detected

Forecast of Cause : 1. Connector connection defective, open
 2. Thermistor failure
 3. Main PCB failure

Check Point 1 : Check the connector connection and cable open

- Connector connection state check
- Cable open check

↓ OK

Check Point 2 : Check the thermistor

- Thermistor characteristics check (Disconnect the thermistor from the PCB and check.)
 * For the thermistor characteristics, refer to the "Service Parts Information 5".

↓ OK

Check Point 3 : Check voltage of Main PCB (DC5.0V)

- Main PCB (CN66:1-3) voltage value = 5V
 Remove the thermistor from Main PCB, check the voltage.

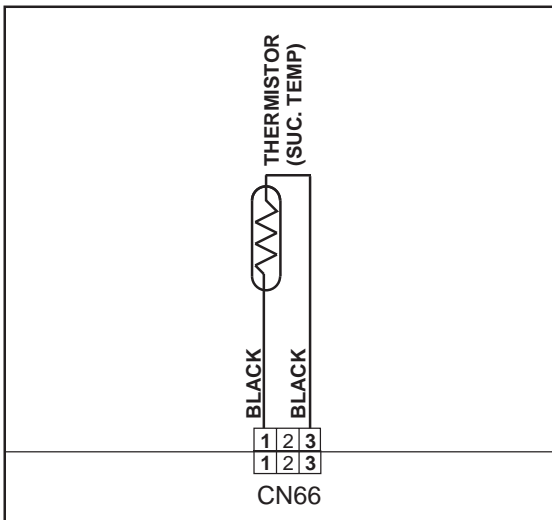

Suction gas temperature thermistor (CN66:1-3)

► **If the voltage does not appear, replace Main PCB, and execute the check operation.**

Trouble shooting 22
OUTDOOR UNIT Error Method:
Heat Sink Thermistor Error

Indicate or Display:
Outdoor Unit : E. 77. 1
Indoor Unit : Operation LED 7 times Flash, Timer LED 7 Times Flash,
Economy LED Continuous Flash.
Error Code : 77

Detective Actuators:

Inverter PCB

Detective details:

- Heat sink temperature thermistor (Built-in IPM) open/short detected

Forecast of Cause : 1. Inverter PCB failure

▶ **If this error is displayed, replace Inverter PCB**

Trouble shooting 23
OUTDOOR UNIT Error Method:
 Sub-cool Heat EX. Gas Inlet
 Thermistor Error

Indicate or Display:
 Outdoor Unit : E. 82. 1
 Indoor Unit : Operation LED 8 times Flash, Timer LED 2 Times Flash,
 Economy LED Continuous Flash.
 Error Code : 82

Detective Actuators:

Sub-cooling heat exchanger gas inlet
 temperature thermistor

Detective details:

- Sub-cooling heat exchanger gas inlet temperature thermistor short or open detected

- Forecast of Cause :**
1. Connector connection defective, open
 2. Thermistor failure
 3. Main PCB failure

Check Point 1 : Check the connector connection and cable open

- Connector connection state check
- Cable open check



Check Point 2 : Check the thermistor

- Thermistor characteristics check (Disconnect the thermistor from the PCB and check.)
 * For the thermistor characteristics, refer to the "Service Parts Information 5".



Check Point 3 : Check voltage of Main PCB (DC5.0V)

- Main PCB (CN65:1-2) voltage value = 5V
 Remove the thermistor from Main PCB, check the voltage.

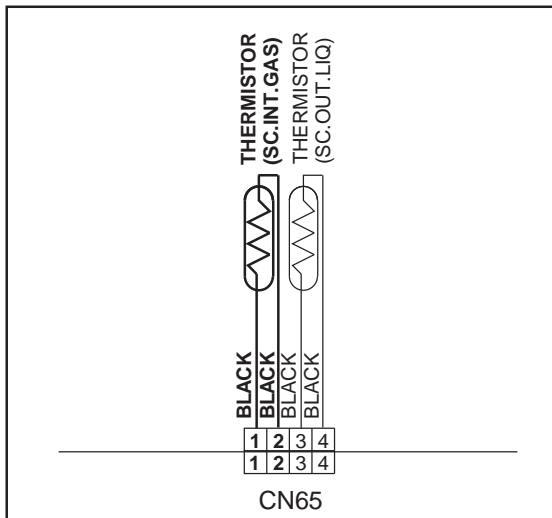

Sub-cooling heat exchanger gas inlet thermistor (CN65:1-2)

► **If the voltage does not appear, replace Main PCB, and execute the check operation again.**

Trouble shooting 24 OUTDOOR UNIT Error Method: Sub-cool Heat Ex. Gas Outlet Thermistor Error	Indicate or Display: Outdoor Unit : E. 82. 2 Indoor Unit : Operation LED 8 times Flash, Timer LED 2 Times Flash, Economy LED Continuous Flash. Error Code : 82
---	---

Detective Actuators: Sub-cooling heat exchanger gas outlet temperature thermistor	Detective details: • Sub-cooling heat exchanger gas outlet temperature thermistor short or open detected
---	--

Forecast of Cause :

1. Connector connection failur, open
2. Thermistor failure
3. Main PCB failure

Check Point 1 : Check the connector connection and cable open

- Connector connection state check
- Cable open check

↓ **OK**

Check Point 2 : Check the thermistor

- Thermistor characteristics check (Disconnect the thermistor from the PCB and check.)
 * For the thermistor characteristics, refer to the "Service Parts Information 5".

↓ **OK**

Check Point 3 : Check voltage of Main PCB (DC5.0V)

DC

- Main PCB (CN63:4-5) voltage value = 5V
 Remove the thermistor from Main PCB, check the voltage.

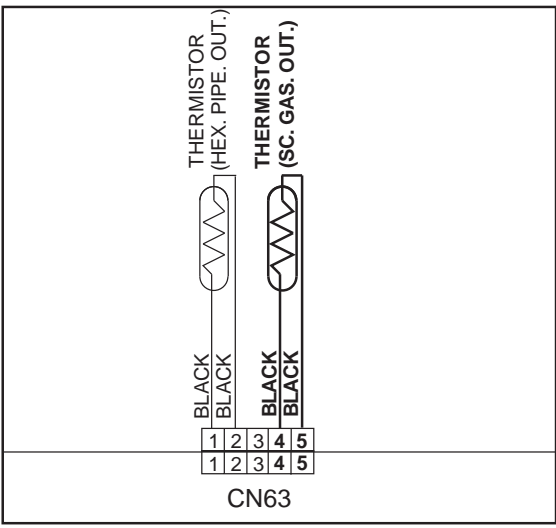

Heat exchanger liquid outlet thermistor (CN63:4-5)

▶ **If the voltage does not appear, replace Main PCB, and execute the check operation again.**

Trouble shooting 25 OUTDOOR UNIT Error Method: Liquid Pipe Thermistor Error	Indicate or Display: Outdoor Unit : E. 83. 1 Indoor Unit : Operation LED 8 times Flash, Timer LED 3 Times Flash, Economy LED Continuous Flash. Error Code : 83
--	---

Detective Actuators: Heat exchanger liquid outlet thermistor	Detective details: • Heat exchanger liquid pipe thermistor short or open detected
--	---

Forecast of Cause :

1. Connector connection failur, open
2. Thermistor failure
3. Main PCB failure

Check Point 1 : Check the connector connection and cable open

- Connector connection state check
- Cable open check

↓ **OK**

Check Point 2 : Check the thermistor

- Thermistor characteristics check (Disconnect the thermistor from the PCB and check.)
* For the thermistor characteristics, refer to the "Service Parts Information 5".

↓ **OK**

Check Point 3 : Check voltage of Main PCB (DC5.0V)

DC

- Main PCB (CN63:1-2) voltage value = 5V
Remove the thermistor from Main PCB, check the voltage.

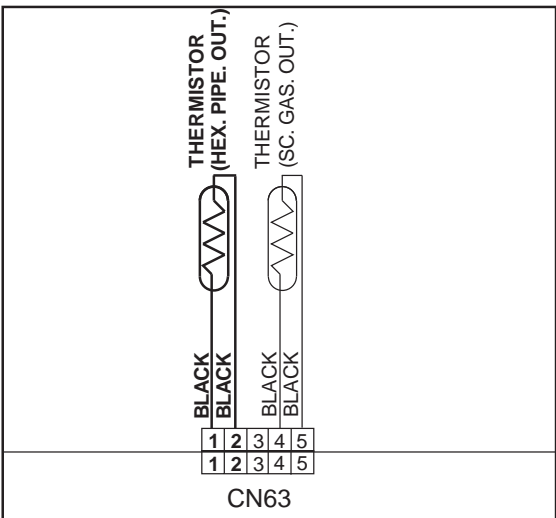

Heat exchanger liquid outlet thermistor (CN63:1-2)

► **If the voltage does not appear, replace Main PCB, and execute the check operation again.**

Trouble shooting 26
OUTDOOR UNIT Error Method:
Current Sensor Error

Indicate or Display:
Outdoor Unit : E. 84. 1
Indoor Unit : Operation LED 8 times Flash, Timer LED 4 Times Flash, Economy LED Continuous Flash.
Error Code : 84

Detective Actuators:

Judgment from value sensed by current sensor (current sensor for inverter)
* Current sensor is mounted on Filter PCB

Detective details:

• When the compressor stops and 30seconds has passed, and the current value from INVERTER is over than 15A, outdoor unit is stopped permanently by protection.

Forecast of Cause : 1. Filter PCB to Inverter PCB CT system wiring connector disconnection, open
2. Filter PCB failure (Power supply section, current sensor section)
3. Inverter PCB failure

Check Point 1 : Filter PCB to Inverter PCB CT system wiring connection state

- Connector and wiring connection state check
- Cable open check

↓ OK

Check Point 2 : Check Filter PCB and Inverter PCB

▶ If Check Point 1 do not improve the symptom, replace Filter PCB.

↓ NG

Check Point 3 : Check Filter PCB and Inverter PCB

▶ If Check Point 2 do not improve the symptom, replace Inverter PCB.

Trouble shooting 27
OUTDOOR UNIT Error Method:
Discharge Pressure Sensor Error

Indicate or Display:
Outdoor Unit : E. 86. 1
Indoor Unit : Operation LED 8 times Flash, Timer LED 6 Times Flash, Economy LED Continuous Flash.
Error Code : 86

Detective Actuators:

Discharge pressure sensor

Detective details:

- When any of the following conditions is satisfied, a discharge pressure sensor error is generated.
 1. 30 seconds or more have elapsed since the outdoor unit power was turned on and pressure sensor detected value < 0.3V continued for 30 seconds or more
 2. 30 seconds or more have elapsed since the outdoor unit power was turned on and pressure sensor detected value \geq 5.0V was detected.

- Forecast of Cause :**
1. Discharge pressure sensor connector disconnection, open
 2. Discharge pressure sensor failure
 3. Main PCB failure

Check Point 1 : Check the discharge pressure sensor connection state

- Connector connection state check
- Cable open check



Check Point 2 : Check the discharge pressure sensor

- Sensor characteristics check
- * For the characteristics of the discharge pressure sensor, refer to the "Service Parts Information 6".



Check Point 3 : Check voltage of Main PCB (DC5.0V)

- Main PCB (CN91:1-4) voltage value = 5V
Remove the thermistor from Main PCB, check the voltage.

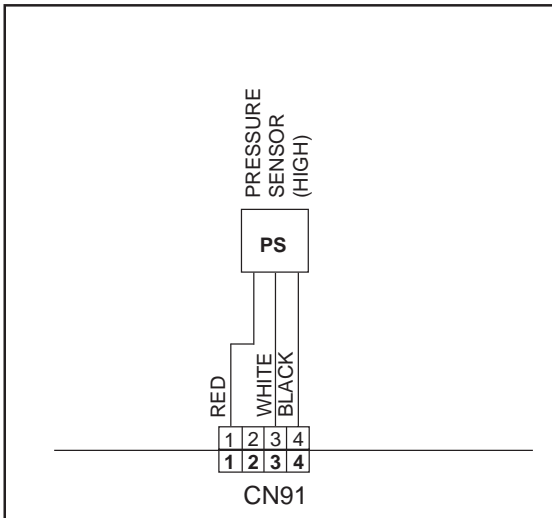

Discharge pressure sensor (CN91:1-4)

► **If the voltage does not appear, replace Main PCB, and execute the check operation again.**

Trouble shooting 28
OUTDOOR UNIT Error Method:
Suction Pressure Sensor Error

Indicate or Display:
Outdoor Unit : E. 86. 3
Indoor Unit : Operation LED 8 times Flash, Timer LED 6 Times Flash, Economy LED Continuous Flash.
Error Code : 86

Detective Actuators:

Suction pressure sensor

Detective details:

- When any of the following conditions is satisfied, a suction pressure sensor error is generated.
 1. 30 seconds or more have elapsed since the outdoor unit power was turned on and pressure sensor detected value < 0.06V continued for 30 seconds or more.
 2. 30 seconds or more have elapsed since the outdoor unit power was turned on and pressure sensor detected value \geq 5.0V was detected.

- Forecast of Cause :**
1. Suction pressure sensor connector disconnection, open
 2. Suction pressure sensor failure
 3. Main PCB failure

Check Point 1 : Check the suction pressure sensor connection state

- Connector connection state check
- Cable open check



Check Point 2 : Check the suction pressure sensor

- Sensor characteristics check
- * For the characteristics of the suction pressure sensor, refer to the "Service Parts Information 6".



Check Point 3 : Check voltage of Main PCB (DC5.0V)



- Main PCB (CN92:1-3) voltage value = 5V
 Remove the thermistor from Main PCB, check the voltage.

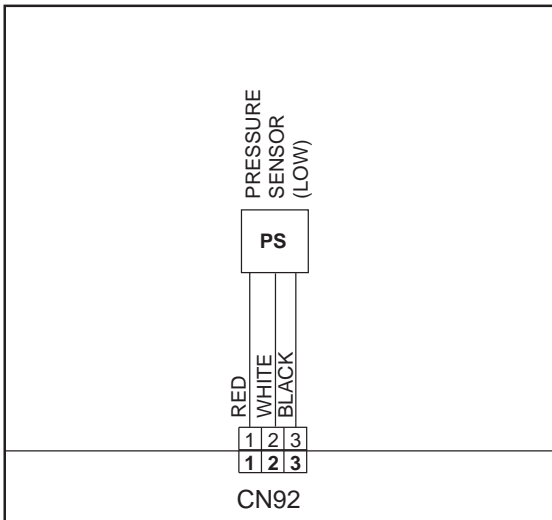

Suction pressure sensor (CN92:1-3)

► **If the voltage does not appear, replace Main PCB, and execute the check operation again.**

Trouble shooting 29 OUTDOOR UNIT Error Method: High Pressure Switch Error	Indicate or Display: Outdoor Unit : E. 86. 4 Indoor Unit : Operation LED 8 times Flash, Timer LED 6 Times Flash, Economy LED Continuous Flash. Error Code : 86
--	---

Detective Actuators: High pressure switch	Detective details: • When the power was turned on, "high pressure switch : open" was detected.
---	--

Forecast of Cause : 1. High pressure switch connector disconnection, open 2. High pressure switch characteristics failure3. Main PCB failure
--

Check Point 1 : Check the high pressure switch connection state

- Connector and wiring connection state check
- Cable open check

↓ **OK**

Check Point 2 : Check the high pressure switch characteristics

- Switch characteristics check
* For the characteristics of high pressure switch, refer to below.

↓ **OK**

Check Point 3 : Replace Main PCB

- Change Main PCB, and execute the check operation again.

• Type of contact

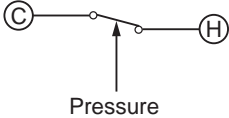

• Characteristics of pressure switch (CN101)

	Pressure switch 1
Contact : Short ⇒ Open	608.7±14.5 PSI
Contact : Open ⇒ Short	463.8±21.7 PSI

Trouble shooting 30 OUTDOOR UNIT Error Method: Over Current Error	Indicate or Display: Outdoor Unit : E. 94. 1 Indoor Unit : Operation LED 9 times Flash, Timer LED 4 Times Flash, Economy LED Continuous Flash. Error Code : 94
--	---

Detective Actuators: Inverter PCB	Detective details: <ul style="list-style-type: none"> ▪ "Protection stop by "overcurrent generation after inverter compressor start processing completed"" generated consecutively 10 times. * The number of generations is reset if the start-up of the compressor succeeds.
---	---

Forecast of Cause .:	1. Outdoor unit fan operation defective, foreign matter on hear exchanger, excessive rise of ambient temperature 2. Inverter PCB failure 3. Inverter compressor failure (lock, winding short)
-----------------------------	---

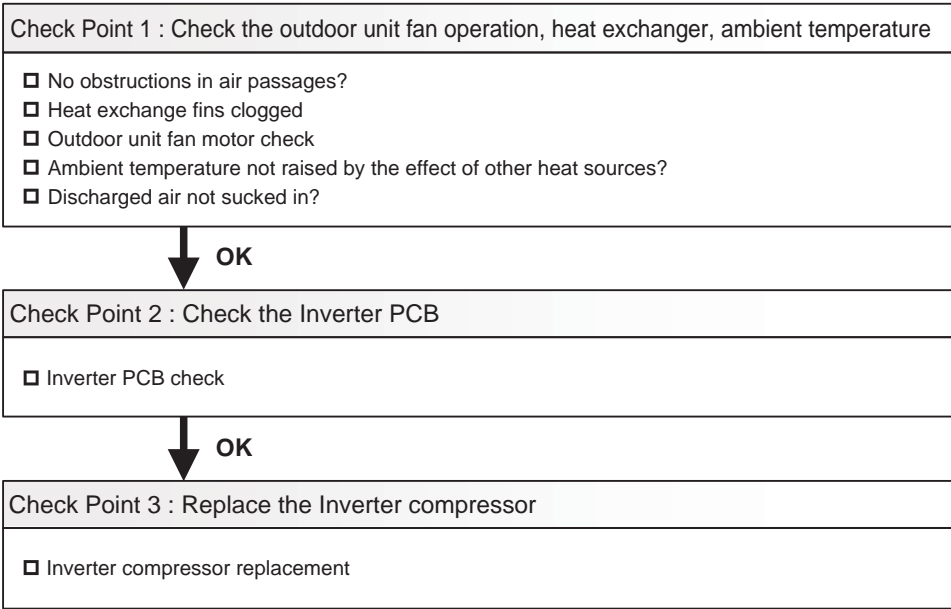

Trouble shooting 31 <u>OUTDOOR UNIT Error Method:</u> Compressor Control Error	<u>Indicate or Display:</u> Outdoor Unit : E. 95. 1 Indoor Unit : Operation LED 9 times Flash, Timer LED 5 Times Flash Economy LED Continuous Flash. Error Code : 95
---	---

<u>Detective Actuators:</u> Outdoor Unit Inverter PCBCompressor	<u>Detective details:</u> When "compressor location detection error" is detected consecutively 5 times, within 40 seconds after start-up. (Compressor location detection becomes over than 90°)
---	--

Forecast of Cause :
 1. Connector connection failure 2. Inverter PCB failure 3.Compressor failure

Check Point 1 : Check connections condition in control unit

- Check if the terminal connection is loose.
- Check if connector is removed.
- Check if connector is erroneous connection.
- Check if cable is open.

>> **Upon correcting the removed connector or mis-wiring, reset the power.**

↓ **OK**

Check Point 2 : Check the Inverter PCB to inverter compressor connection state

- Wiring connection state check
- Cable open check

↓ **OK**

Check Point 3 : Check the Inverter compressor

- Inverter compressor check (Refer to Service Parts Information 1. 2)

↓ **OK**

Check Point 4 : Replace the Inverter PCB

▶ **If Check Point 1~3 do not improve the symptom, replace Inverter PCB.**

↓ **NG**

Check Point 5 : Replace the Inverter compressor

▶ **If Check Point 4 do not improve the symptom, replace Inverter compressor.**

Trouble shooting 32 OUTDOOR UNIT Error Method: Outdoor Unit Fan Motor Error	Indicate or Display: Outdoor Unit : E. 97. 3 Indoor Unit : Operation LED 9 times Flash, Timer LED 7 Times Flash, Economy LED Continuous Flash. Error Code : 97
--	---

Detective Actuators: Outdoor unit fan motor Outdoor unit Main PCB	Detective details: ① When fan speed < 100rpm within 20 seconds after fan motor operation issued, fan motor is stopped by protection stop. ② When protection ① repeats 3 times within 60minutes, compressor and fan motor are stopped by protection stop. * The number of generations is reset if the protection ① not detects within 60 seconds. ③ When protection ② repeats 5 times, compressor and fan motor are stopped by protection stop. * The number of generations is reset if the protection ① not detects within 60 seconds after protection stop ②
--	---

Forecast of Cause : <ol style="list-style-type: none"> 1. Rotation obstruction by foreign object 2. Motor wiring, connector disconnected, open 3. Fan motor failure (winding open, lock) 4. Main PCB failure (drive circuit, speed detection circuit)
--

Check Point 1 : Fan rotation state check
<input type="checkbox"/> Check for the absence of foreign matter around the fan.



Check Point 2 : Check the motor wiring, connector disconnection, open
<input type="checkbox"/> Check for motor wiring connector disconnection, open.



Check Point 3 : Fan motor defective
<input type="checkbox"/> Check if fan can be rotated by hand. <input type="checkbox"/> Motor winding resistance check(PARTS INFORMATION 7) <input type="checkbox"/> Motor operation check



Check Point 4 : Check output voltage of Main PCB	<div style="border: 1px solid black; padding: 2px; display: inline-block;"> DC </div>
<ul style="list-style-type: none"> · Check outdoor unit circuit diagram and the voltage. (Measure at Main PCB side connector 243) <p>>>1 pin(Red) - 4 pin(Black) DC250V ~ 400V >>4 pin(Black) - 5 pin(White) DC15V ±2V</p>	
<p>► If the voltage is not correct, replace Main PCB, and execute the check operation again.</p>	

Trouble shooting 33 OUTDOOR UNIT Error Method: 4-way valve error	Indicate or Display: Outdoor Unit : E. 99. 1 Indoor Unit : Operation LED 9 times Flash, Timer LED 9 Times Flash Economy LED Continuous Flash. Error Code : 99
---	--

Detective Actuators: Indoor Unit Controller PCB Circuit Heat Exchanger Temperature Thermistor Room Temperature Thermistor 4-way valve	Detective details: When the indoor heat exchanger temperature is compared with the room temperature, and either following condition is detected continuously two times, the compressor stops. •Cooling or Dry operation [Indoor heat exchanger temp.] - [Room temp.] > 50degF •Heating operation [indoor heat exchanger temp.] - [Room temp.] < -50degF If the same operation is repeated 2 times, the compressor stops permanently.
--	---

Forecast of Cause : 1. Connector connection failure 2. Thermistor failure 3. Coil failure 4. 4-way valve failure 5. Main PCB failure

Check Point 1 : Check connection of Connector • Check if connector is removed. • Check erroneous connection. • Check if thermistor cable is open. >> Upon correcting the removed connector or mis-wiring, reset the power.
--

↓
OK

Check Point 2 : Check thermistor • Isn't it fallen off the holder? • Is there a cable pinched? >> Check characteristics of thermistor, If defective, replace the thermistor.

↓
OK

Check Point 3 : Check the solenoid coil and 4-way valve [Solenoid coil] • Remove CN30 from PCB and check the resistance value of coil. Resistance value is about 1.4kΩ >> If it is Open or abnormal resistance value, replace Solenoid Coil. [4-way valve] • Check each piping temperature, and the location of the valve by the temperature difference. >> If the value location is not proper, replace 4-way valve.
--

↓
OK

Check Point 4 : Replace Main PCB ▶ If Check Point 1- 3 do not improve the symptom, replace Main PCB, and execute the check operation again.
--

Trouble shooting 34 OUTDOOR UNIT Error Method: Discharge Temp. Error	Indicate or Display: Outdoor Unit : E. A1. 1 Indoor Unit : Operation LED 10 times Flash, Timer LED 1 Times Flash, Economy LED Continuous Flash. Error Code : A1
---	--

Detective Actuators: Discharge temperature thermistor	Detective details: • "Protection stop by "discharge temperature \geq 239degF during compressor operation"" generated 2 times within 24 hours.
---	---

Forecast of Cause : <ol style="list-style-type: none"> 1. 3-way valve not opened 2. EEV defective, strainer clogged 3. Outdoor unit operation failure, foreign matter on heat exchanger 4. Discharge temperature thermistor failure 5. Insufficient refrigerant

<Cooling operation>

Check Point 1 : Check if 3-way valve(gas side) is open.

If the 3-way valve(gas side) was closed, open the 3-way valve(gas side) and check operation.

↓ **OK**

Check Point 2 : Check the EEV, strainer

EEV (EEV2, indoor unit EEV) open?
 Strainer clogging check (before and after EEV, ACM oil return)
 Refer to "Service Parts Information 3, 4"

↓ **OK**

Check Point 3 : Check the outdoor unit fan,heat exchanger

Check for foreign object at heat exchanger
 Check if fan can be rotated by hand.
 Motor check(PARTS INFORMATION 7)

↓ **OK**

Check Point 4 : Check the discharge thermistor

Discharger thermistor characteristics check (Check by disconnecting thermistor from PCB.)
 * For the characteristics of the thermistor, refer to the "Service Parts Information 5".

↓ **OK**

Check Point 5 : Check the refrigerant amount

Leak check

<Heating operation>

Check Point 1 : Check if 3-way valve(liquid side) is open.

If the 3-way valve(liquid side) was closed, open the 3-way valve(liquid side) and check operation.

↓ **OK**

Check Point 2 : Check the EEV, strainer

EEV (EEV1, EEV2) open?
 Strainer clogging check (before and after EEV, ACM oil return)
 Refer to "Service Parts Information 3, 4"

↓ **OK**

Trouble shooting 35 OUTDOOR UNIT Error Method: Compressor Temp. Error	Indicate or Display: Outdoor Unit : E. A3. 1 Indoor Unit : Operation LED 10 times Flash, Timer LED 3 Times Flash, Economy LED Continuous Flash. Error Code : A3
--	--

Detective Actuators: Compressor temperature thermistor	Detective details: • "Protection stop by "compressor temperture" \geq 233degF during compressor operation""generated 2 times within 24 hours
--	--

Forecast of Cause :	1. 3-way valve not opened 2. EEV defective, strainer clogged 3. Outdoor unit operation failure, foreign matter on heat exchanger 4. Compressor temperature thermistor failure 5. Insufficient refrigerant
----------------------------	---

<Cooling operation>

Check Point 1 : Check if 3-way valve(gas side) is open.
<input type="checkbox"/> If the 3-way valve(gas side) was closed, open the 3-way valve(gas side) and check operation.

↓
OK

Check Point 2 : Check the EEV, strainer
<input type="checkbox"/> EEV (EEV2, indoor unit EEV) open? <input type="checkbox"/> Strainer clogging check (before and after EEV, ACM oil return) Refer to "Service Parts Information 3, 4".

↓
OK

Check Point 3 : Outdoor unit fan, heat exchanger chek
<input type="checkbox"/> Check for foreign object at heat exchanger <input type="checkbox"/> Check if fan can be rotated by hand. <input type="checkbox"/> Motor check(PARTS INFORMATION 7)

↓
OK

Check Point 4 : Check the compressor temperature thermistor
<input type="checkbox"/> Compressor temperature thermistor characteristics check (Check by disconnecting thermistor from PCB) * For the characteristics of the thermistor, refer to the "Service Parts Information 5.

↓
OK

Check Point 5 : Check the refrigerant amount
<input type="checkbox"/> Leak check

<Heating operation>

Check Point 1 : Check if 3-way valve(liquid side) is open.
<input type="checkbox"/> If the 3-way valve(liquid side) was closed, open the 3-way valve(liquid side) and check operation.

↓
OK

Check Point 2 : Check the EEV, strainer
<input type="checkbox"/> EEV (EEV1, EEV2) open? <input type="checkbox"/> Strainer clogging check (before and after EEV, ACM oil return) Refer to "Service Parts Information 3,4 ".

↙
OK

Trouble shooting 36 OUTDOOR UNIT Error Method: Low Pressure Error	Indicate or Display: Outdoor Unit : E. A5. 1 Indoor Unit : Operation LED 10 times Flash, Timer LED 5 Times Flash, Economy LED Continuous Flash. Error Code : A5
--	--

Detective Actuators: Suction pressure sensor	Detective details: <ul style="list-style-type: none"> · "Protection stop by suction pressure \leq 7.35PSI continued for 5 minutes" repeats 5 times within 2 hours.
--	--

Forecast of Cause :	1. 3-way valve not opened 2. Outdoor unit ambient temperature too low 3. Outdoor unit fan operation defective, foreign matter at heat exchanger 4. EEV defective, strainer clogged 5. Solenoid valve defective 6. Low pressure sensor characteristics defective 7. Insufficient refrigerant
----------------------------	--

<Cooling operation>

Check Point 1 : Check if 3-way valve(gas side) is open.
<input type="checkbox"/> If the 3-way valve(gas side) was closed, open the 3-way valve(gas side) and check operation.



strainer clogging
<input type="checkbox"/> Indoor unit EEV operation check <input type="checkbox"/> Strainer not clogged?



Check Point 5 : Check the solenoid valve (SV1)
<input type="checkbox"/> Solenoid valve operation check



Check Point 6 : Check the suction pressure sensor
<input type="checkbox"/> Suction pressure sensor characteristics check * For the characteristics of the suction pressure sensor (PARTS INFORMATION 5)



Check Point 7 : Check the refrigerant amount
<input type="checkbox"/> Leak check

<Heating operation>

Check Point 1 : Check if 3-way valve(liquid side) is open.
<input type="checkbox"/> If the 3-way valve(liquid side) was closed, open the 3-way valve(liquid side) and check operation.



Check Point 2 : Check the outdoor unit ambient temperature
<input type="checkbox"/> Outdoor ambient temperature lower than operating range?



Check Point 3 : Check the outdoor unit fan operation, heat exchanger
<input type="checkbox"/> No foreign object in air passage? <input type="checkbox"/> Heat exchange fins clogged <input type="checkbox"/> Fan rotates? <input type="checkbox"/> Outdoor unit fan motor check



Check Point 4 : Check the outdoor unit EEV, strainer clogging
<input type="checkbox"/> Outdoor unit EEV1 operation check <input type="checkbox"/> Strainer not clogged? Refer to "Service Parts Information 3"



<p>Trouble shooting 37 Branch Box Error Method: Connected combination error</p>	<p>Indicate or Display: Outdoor Unit : E. 11. 3 Branch Box : LED401/ 402/ 403/ 404/ 405 Lit Indoor Unit : Operation LED 1times Flash, Timer LED 1times Flash, Economy LED Flashing (0.1s ON / 0.1s OFF) Error Code : 11</p>
--	--

<p><u>Detective Actuators:</u> Outdoor unit</p>	<p><u>Detective details:</u> • When another outdoor unit in the future is connected to the terminal "Outdoor unit" of Primary branch box.</p>
---	---

Forecast of Cause : 1. Connected outdoor unit

<p>Check Point 1 : Check the outdoor unit</p>
<p><input type="checkbox"/> Check the outdoor unit >> <u>If there is another outdoor unit, correct it by referring to Installation Manual or Design & Technical Manual.</u> >> <u>Upon correcting incorrect setting, reset the power.</u></p>

<p>Trouble shooting 38 Branch Box Error Method: Power frequency error 1</p>	<p>Indicate or Display: Outdoor Unit : E. 11. 3 or E. 11. 4 Branch Box : LED401/ 402/ 403/ 404 Lit, LED405 Unlit Indoor Unit : Operation LED 1times Flash, Timer LED 1times Flash, Economy LED Flashing (0.1s ON / 0.1s OFF) Error Code : 11</p>
--	---

<p>Detective Actuators: Branch Box Controller PCB</p>	<p>Detective details: • When 4 continuous failures occurred at Power frequency test. (Power supply of Branch Box)</p>
---	--

Forecast of Cause : 1. Connection failure 2. External cause 3. Controller PCB failure

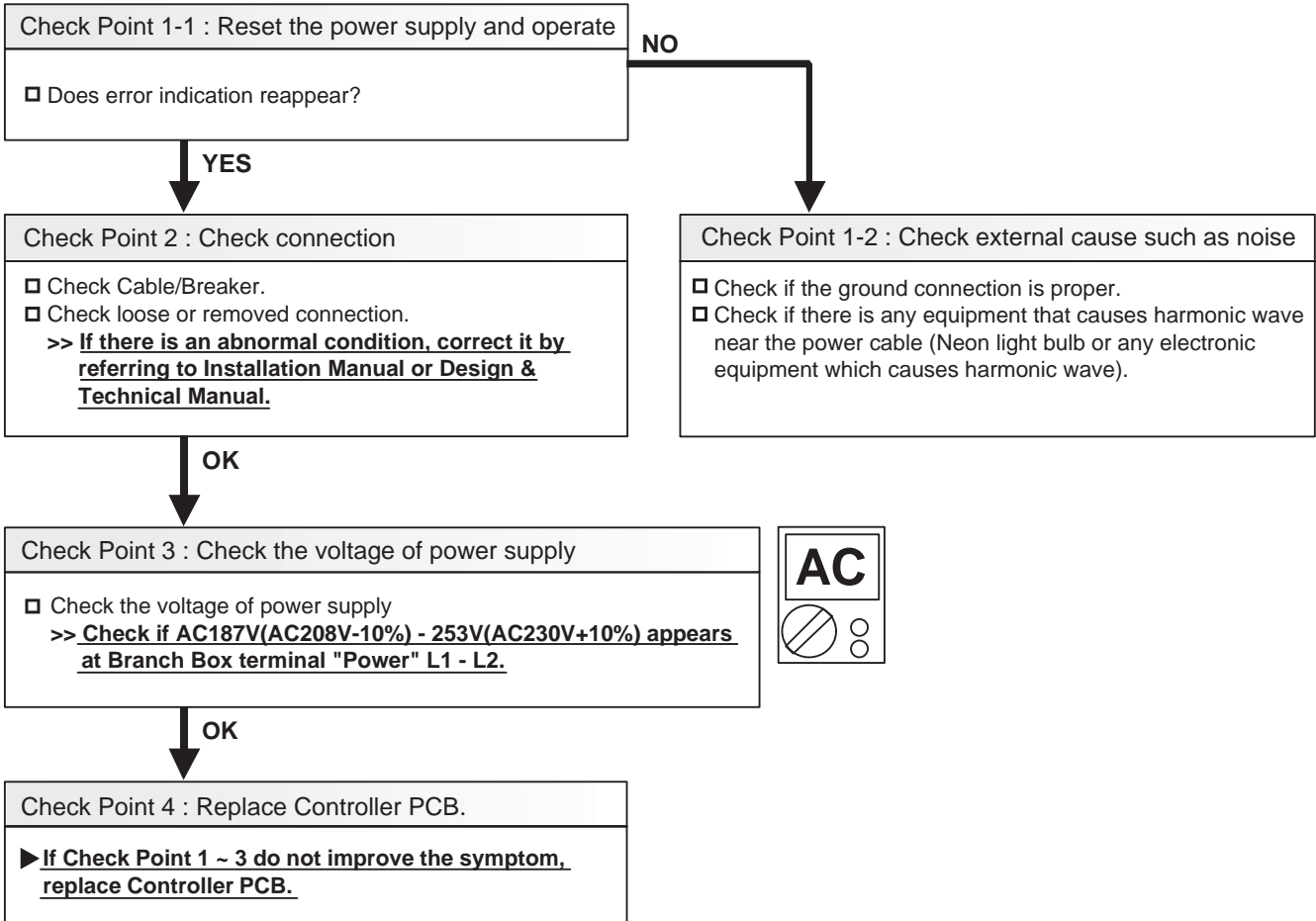

<p>Trouble shooting 39 Branch Box Error Method: Power frequency error 2</p>	<p>Indicate or Display: Outdoor Unit : E. 11. 3 or E. 11. 4 Branch Box : LED401/ 402/ 403 Lit, LED404 Unlit, LED405 Lit Indoor Unit : Operation LED 1times Flash, Timer LED 1times Flash, Economy LED Flashing (0.1s ON / 0.1s OFF) Error Code : 11</p>
--	--

<p>Detective Actuators: Branch Box Controller PCB Outdoor unit Main PCB Outdoor Filter PCB</p>	<p>Detective details:</p> <ul style="list-style-type: none"> When 4 continuous failures occurred at Power frequency test. <ul style="list-style-type: none"> (Branch Box (Primary) : Power supply for communication to outdoor unit. Branch Box (Secondary) : Power supply for communication to primary branch box.)
--	--

<p>Forecast of Cause : 1. Connection failure 2. External cause 3. Controller PCB failure 4. Outdoor Main PCB failure 5. Outdoor Filter PCB failure</p>

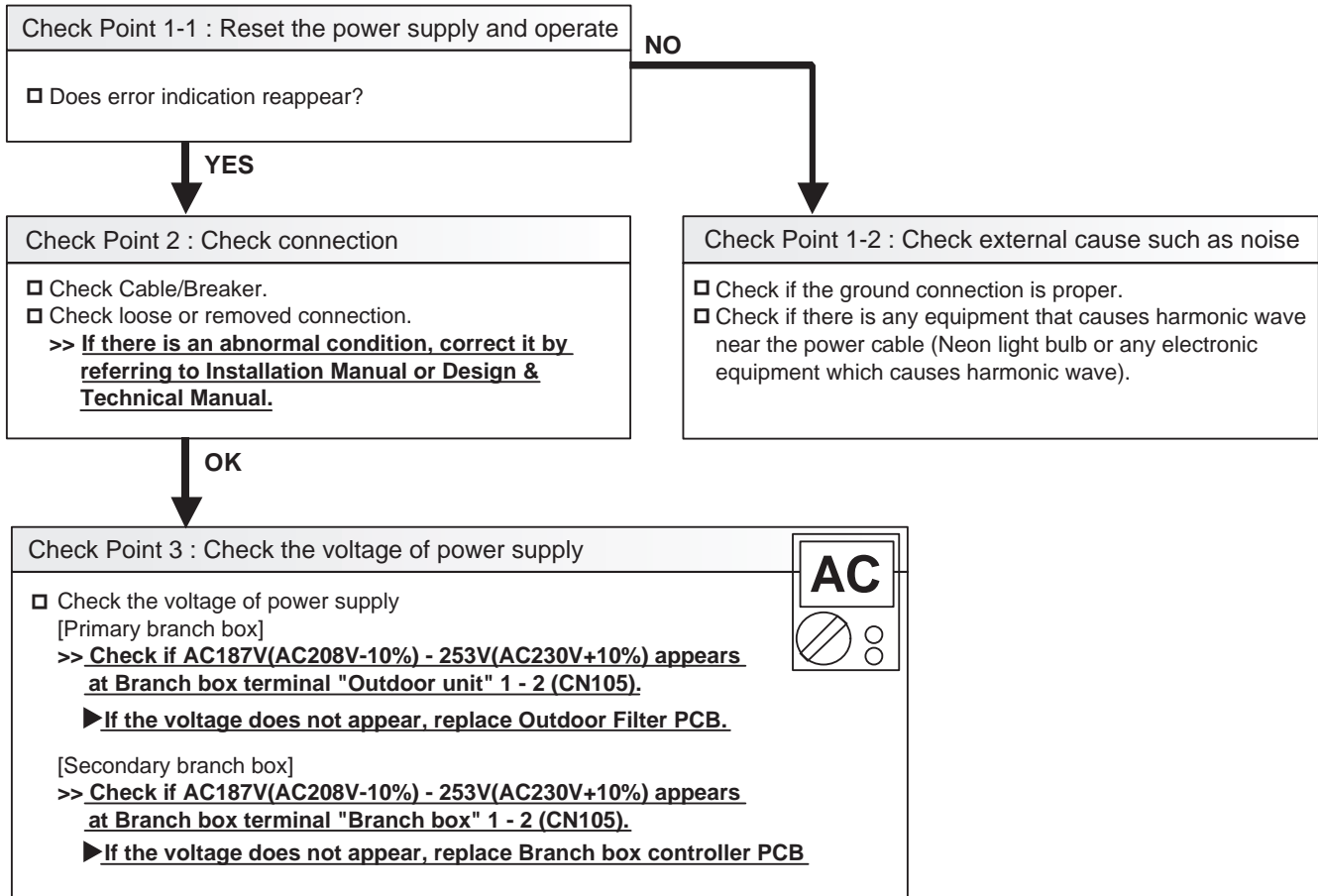

Trouble shooting 40 Branch Box Error Method: EEPROM access error	Indicate or Display: Outdoor Unit : E. J2. U Branch Box : LED402 1time Flash, LED403/ 404/ 405 Unlit Indoor Unit : Operation LED 13times Flash, Timer LED 2times Flash, Economy LED Flashing (0.1s ON / 0.1s OFF) Error Code : J2
---	--

Detective Actuators: Branch Box Controller PCB	Detective details: • When power is on and the access to EEPROM failed.
--	--

Forecast of Cause : 1. External cause 2. Defective for connection in controller unit 3. Controller PCB failure

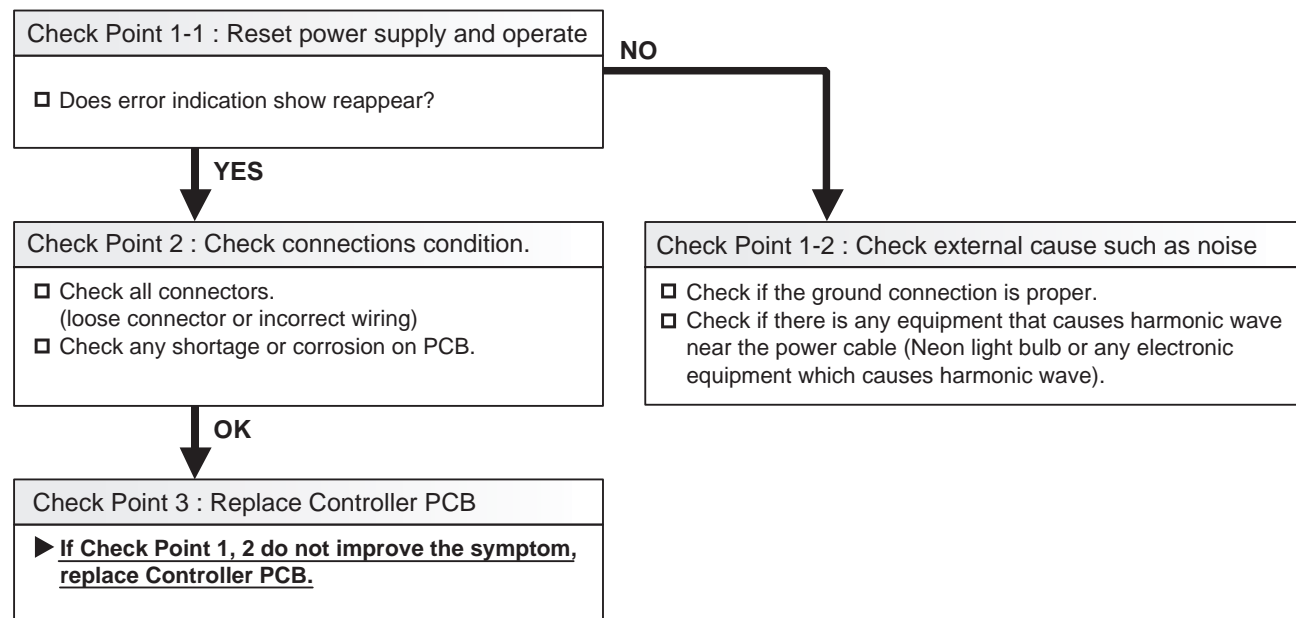

Trouble shooting 41 Branch Box Error Method: Model information error	Indicate or Display: Outdoor Unit : E. J2. U Branch Box : LED402 2times Flash, LED403/ 404/ 405 Unlit Indoor Unit : Operation LED 13times Flash, Timer LED 2times Flash, Economy LED Flashing (0.1s ON / 0.1s OFF) Error Code : J2
---	---

Detective Actuators: Branch Box Controller PCB	Detective details: · When power is on and model information of EEPROM is incorrect.
--	---

Forecast of Cause : 1. External cause 2. Defective for connection in controller unit 3. Controller PCB failure

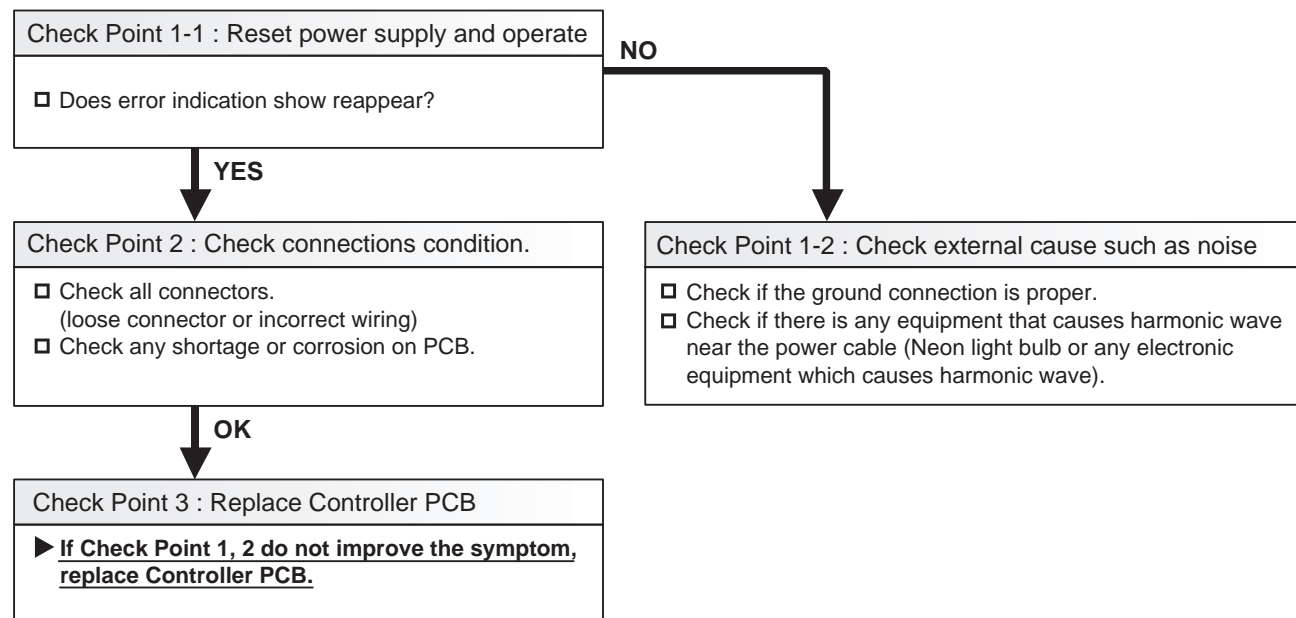

Trouble shooting 42 Branch Box Error Method: Indoor Unit A, B, C, liquid pipe thermistor error (CN309 / 310)	Indicate or Display: Outdoor Unit : E. J2. U Branch Box : LED402 6times Flash (Indoor unit A): LED403 Lit, LED404/ 405 Unlit (Indoor unit B): LED403 Unlit, LED404 Lit, LED405 Unlit (Indoor unit C): LED403/ 404 Unlit, LED405 Lit Indoor Unit : Operation LED 13times Flash, Timer LED 2times Flash, Economy LED Flashing (0.1s ON / 0.1s OFF) Error Code : J2
---	--

Detective Actuators: Branch Box Controller PCB Indoor unit A,B,C Liquid pipe Thermistor	Detective details: · When open or shorted Liquid pipe Thermistor is detected.
--	---

Forecast of Cause : 1. Connection failure 2. Thermistor failure 3. Controller PCB failure

Check Point 1 : Check connection of Connector

- Check if connector is loose or removed
- Check erroneous connection
- Check if thermistor cable is open

>>Reset Power when reinstalling due to removed connector or incorrect wiring.



Check Point 2 : Remove connector and check Thermistor resistance value

Thermistor Characteristics (Rough value)

Temperature (°F)	32	41	50	59	68	77	86	95
Resistance Value (kΩ)	168.6	129.8	100.9	79.1	62.5	49.8	40.0	32.4

Temperature (°F)	104	113	122
Resistance Value (kΩ)	26.3	21.2	17.8



► **If Thermistor is either open or shorted, replace it and reset the power.**



Check Point 3 : Check voltage of Controller PCB (DC5.0V)

Make sure circuit diagram of each indoor unit and check terminal voltage at Thermistor (DC5.0V)

- Schematic Diagram (Connector connection)

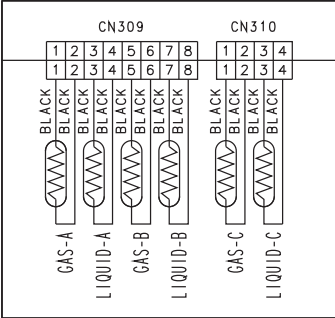

- Liquid pipe Thermistor (Unit A) (CN309 Wire:Black)
- Liquid pipe Thermistor (Unit B) (CN309 Wire:Black)
- Gas pipe Thermistor (Unit A) (CN309 Wire:Black)
- Gas pipe Thermistor (Unit B) (CN309 Wire:Black)
- Liquid pipe Thermistor (Unit C) (CN310 Wire:Black)
- Gas pipe Thermistor (Unit C) (CN310 Wire:Black)



► **If the voltage does not appear, replace Controller PCB .**

<p>Trouble shooting 43 Branch Box Error Method: Indoor Unit A, B, C, gas pipe thermistor error (CN309 / 310)</p>	<p>Indicate or Display: Outdoor Unit : E. J2. U Branch Box : LED402 7times Flash (Indoor unit A): LED403 Lit, LED404/ 405 Unlit (Indoor unit B): LED403 Unlit, LED404 Lit, LED405 Unlit (Indoor unit C): LED403/ 404 Unlit, LED405 Lit Indoor Unit : Operation LED 13times Flash, Timer LED 2times Flash, Economy LED Flashing (0.1s ON / 0.1s OFF) Error Code : J2</p>
---	---

<p>Detective Actuators: Branch Box Controller PCB Circuit Indoor unit A,B,C Gas pipe Thermistor</p>	<p>Detective details: • When open or shorted Liquid pipe Thermistor is detected.</p>
--	--

Forecast of Cause : 1. Connection failure 2. Thermistor failure 3. Controller PCB failure

Check Point 1 : Check connection of Connector

- Check if connector is loose or removed
- Check erroneous connection
- Check if thermistor cable is open

>>Reset Power when reinstalling due to removed connector or incorrect wiring.



Check Point 2 : Remove connector and check Thermistor resistance value

Thermistor Characteristics (Rough value)

Temperature (°F)	32	41	50	59	68	77	86	95
Resistance Value (kΩ)	168.6	129.8	100.9	79.1	62.5	49.8	40.0	32.4

Temperature (°F)	104	113	122
Resistance Value (kΩ)	26.3	21.2	17.8



► If Thermistor is either open or shorted, replace it and reset the power.



Check Point 3 : Check voltage of Controller PCB (DC5.0V)

Make sure circuit diagram of each indoor unit and check terminal voltage at Thermistor (DC5.0V)

- Schematic Diagram (Connector connection)

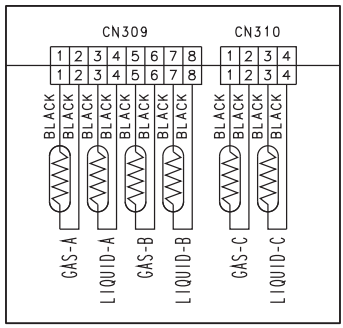

- Liquid pipe Thermistor (Unit A) (CN309 Wire:Black)
- Liquid pipe Thermistor (Unit B) (CN309 Wire:Black)
- Gas pipe Thermistor (Unit A) (CN309 Wire:Black)
- Gas pipe Thermistor (Unit B) (CN309 Wire:Black)
- Liquid pipe Thermistor (Unit C) (CN310 Wire:Black)
- Gas pipe Thermistor (Unit C) (CN310 Wire:Black)



► If the voltage does not appear, replace Controller PCB .

<p>Trouble shooting 44 Branch Box Error Method: Indoor Unit A, B, C, EEV control error (CN305 / 306 / 307)</p>	<p>Indicate or Display: Outdoor Unit : E. J2. U Branch Box : LED402 8times Flash (Indoor unit A): LED403 Lit, LED404/ 405 Unlit (Indoor unit B): LED403 Unlit, LED404 Lit, LED405 Unlit (Indoor unit C): LED403/ 404 Unlit, LED405 Lit Indoor Unit : Operation LED 13times Flash, Timer LED 2times Flash, Economy LED Flashing (0.1s ON / 0.1s OFF) Error Code : J2</p>
---	--

<p>Detective Actuators: Branch Box Controller PCB EEV</p>	<p>Detective details:</p> <ol style="list-style-type: none"> ① In cooling or dry operation, when the Indoor unit heat exchanger temperature becomes lower than 3degC for 5minutes,the compressor stops and EEV is initialized. ② After the compressor restarts, if the same protection is repeated within 1hr, the compressor stops permanently.
--	---

Forecast of Cause : 1. Connection failure 2. EEV failure 3. Controller PCB failure

Check Point 1 : Check Connections

☐ Check Connectors (Loose connector or open cable.)

↓
OK

Check Point 2 : Check Coil of EEV

☐ Remove connector, check each winding resistance of Coil.

Read wire	Resistance value (68°F)
White - Red	46Ω ± 4Ω
Yellow - Red	
Orange - Red	
Blue - Red	

▶ **If Resistance value is abnormal, replace EEV.**



↓
OK

Check Point 3 : Check Voltage from Controller PCB

☐ Remove Connector and check Voltage (DC12V).
>> **If it does not appear, replace Controller PCB.**



↓
OK

↓ OK

Check Point 4 : Check Noise at start up

- Turn on Power and check operation noise.
- >> If an abnormal noise does not show, replace Controller PCB.

↓ OK

Check Point 5 : Check Opening and Closing Operation of Valve

When Valve is closed,
it has a temp. difference between Inlet and Outlet.

CLOSE

Example : Hot Gas
Pipe (In)

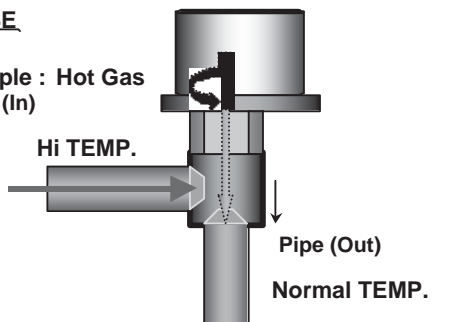

If it is open,
it has no temp. difference between Inlet and Outlet.

OPEN

Example : Hot Gas
Pipe (In)

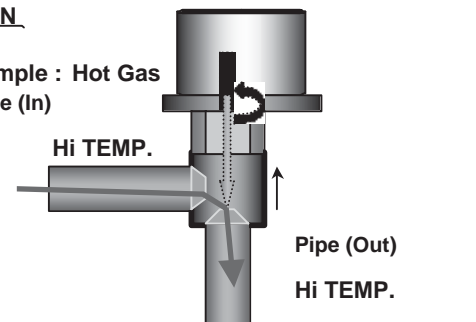

↓ OK

Check Point 6 : Check Strainer

Strainer normally does not have temperature difference between inlet and outlet as shown in (1), but if there is a difference as shown in (2), there is a possibility of inside clogged. In this case, replace Strainer.

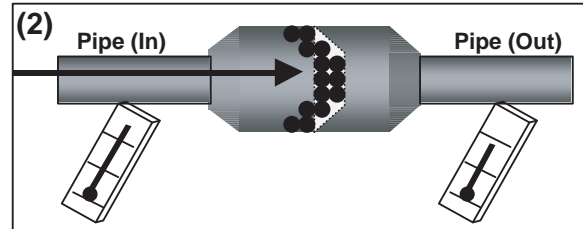
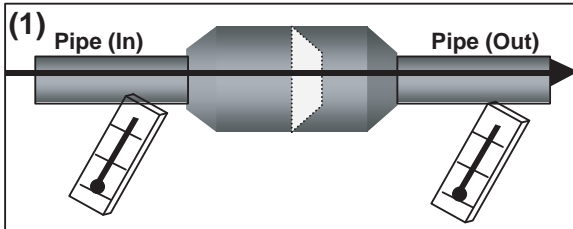

<p>Trouble shooting 45 Branch Box Error Method: Remote controller communication error</p>	<p>Indicate or Display: Outdoor Unit : E. J2. U Branch Box : LED402 9times Flash, LED403/ 404/ 405 unlit Indoor Unit : Operation LED 13times Flash, Timer LED 2times Flash, Economy LED Flashing (0.1s ON / 0.1s OFF) Error Code : J2</p>
--	--

<p>Detective Actuators: Branch Box Controller PCB Home controller</p>	<p>Detective details:</p> <ul style="list-style-type: none"> • More than 1 time of signal from Home controller and other Branch box is received, but it was not received more than 1 minute. • Upon receiving the signal more than 1 time from Home controller, but the same signal has not been received more than 1 minute.
--	--

Forecast of Cause : 1. Terminal connection abnormal 2. Home Controller failure 3. Controller PCB failure

Check Point 1 : Check the connection of terminal

After turning off the power, check & correct the followings.

Branch box - Check the connection of terminal between Home controller and Branch box, or between other Branch boxes, and check if there is a disconnection or short of the cable.



Check Point 2 : Check Home controller and Controller PCB

Check terminal voltage of controller PCB Connector (CN304). (Power supply for Home controller)
If DC12V, Home controller failure (Controller PCB is OK) >>> Replace Home controller
If DC0V, Controller PCB failure (Remote is OK) >>> Replace Controller PCB

► In case of re-installation is done due to removed connector or incorrect wiring, turn on the power again.



Trouble shooting 46 <u>OUTDOOR UNIT Error Method:</u> Display P.C.B. Communication Error	<u>Indicate or Display:</u> Outdoor Unit : E. 6A. 1 Indoor Unit : Operation LED 6 times Flash, Timer LED 10 Times Flash, Economy LED Continuous Flash. Error Code : 6A
---	---

<u>Detective Actuators:</u> Outdoor unit Main PCB Outdoor unit I/O PCB	<u>Detective details:</u> • Communication not received from I/O PCB for 10 seconds or more
---	--

<u>Forecast of Cause :</u> <ol style="list-style-type: none"> 1. Main to I/O PCBs wiring connection defective 2. I/O PCB defective 3. Main PCB defective
--

Check Point 1 : Check the I/O to Main PCB wiring
<input type="checkbox"/> Connector and wiring connection state check <input type="checkbox"/> Cable open check



Check Point 2 : Check I/O PCB and Main PCB
<input type="checkbox"/> If there is the error display at the I/O PCB >> I/O PCB or Main PCB is defective >> Replace I/O PCB or Main PCB <input type="checkbox"/> If there is not the error display at the I/O PCB >> I/O PCB is defective >> Replace I/O PCB <input type="checkbox"/> If Outdoor unit error code is "E.6A.1" and Indoor unit error code is "E.11.1" or "E.11.2" (E.11.1 and E.11.2 is Serial reverse transfer error) >> Main PCB is defective >> Replace Main PCB

2-5 SERVICE PARTS INFORMATION

SERVICE PARTS INFORMATION 1

Compressor

Diagnosis method of Compressor (If outdoor unit LED displays error, refer to Trouble shooting)

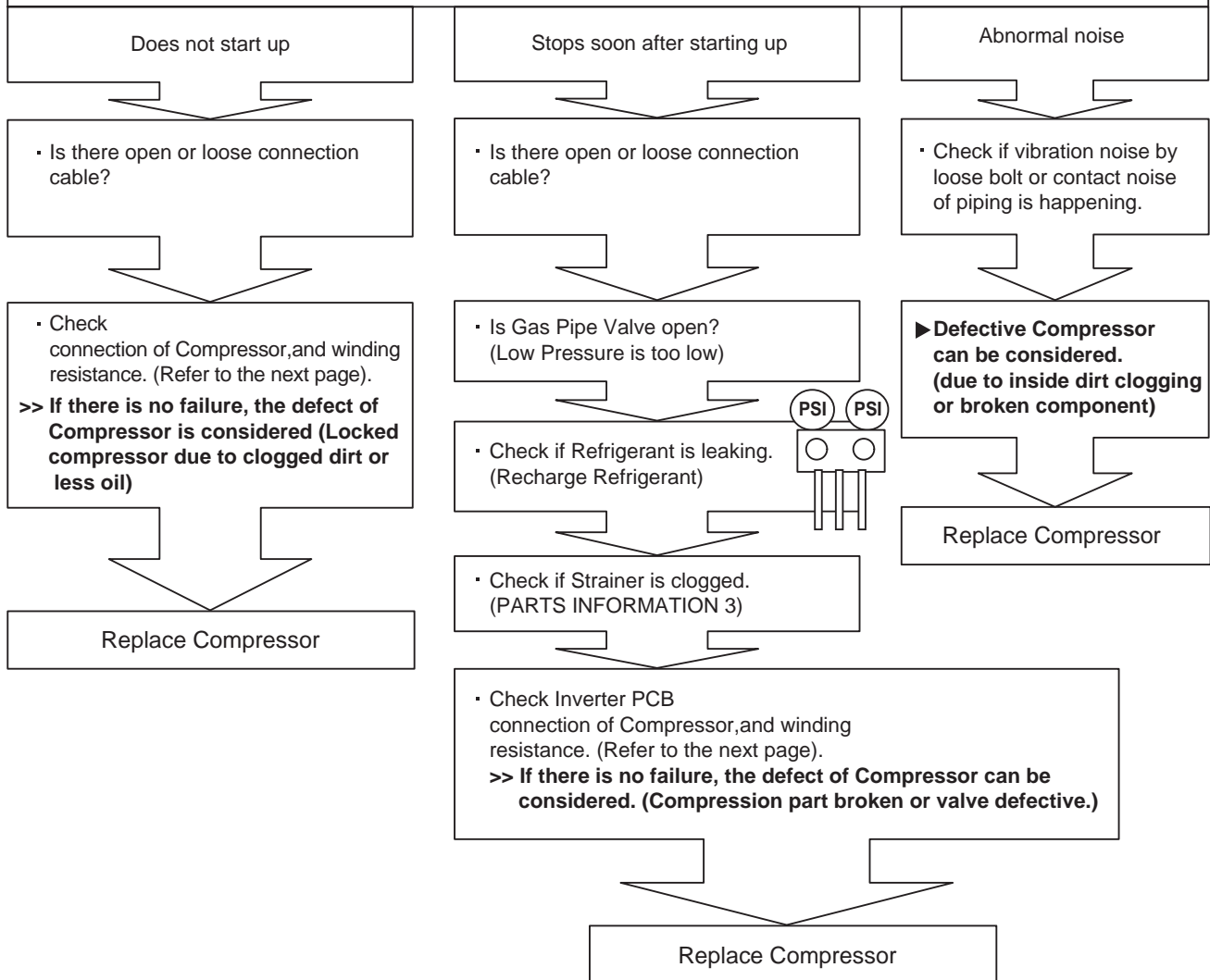

SERVICE PARTS INFORMATION 2

Compressor

Check Point 1 : Check connection

- Check terminal connection of Compressor (Loose or incorrect wiring)

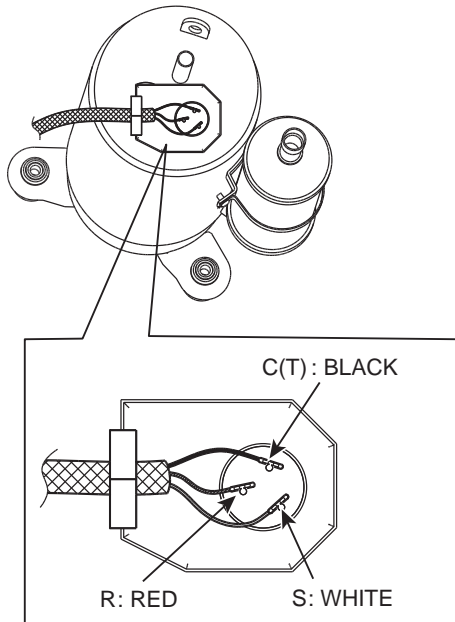

- Check connection of Inverter PCB (Loose or incorrect wiring)

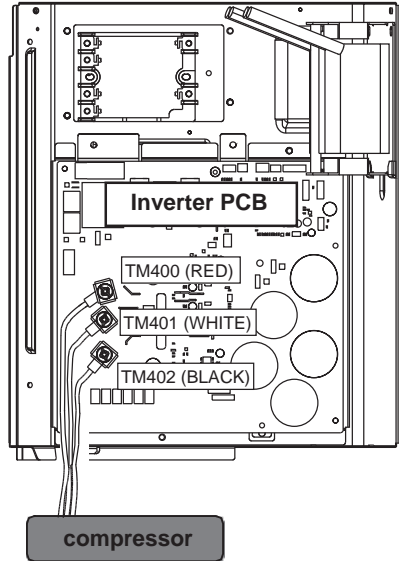

Check Point 2 : Check winding resistance

- Check winding resistance of each terminal
- ▶ **If the resistance value is 0 Ω or infinite, replace Compressor.**

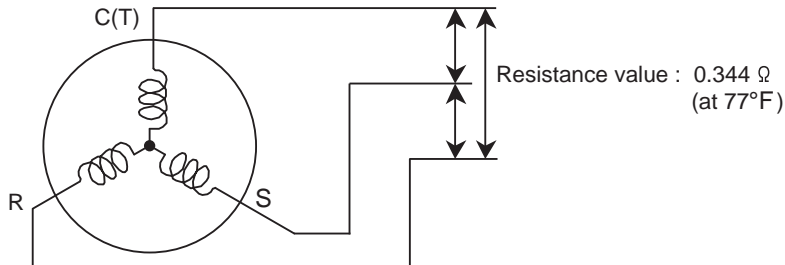

Check Point 3 : Replace Inverter PCB

- ▶ **If Check Point 1, 2 do not improve the symptom, replace Inverter PCB.**

SERVICE PARTS INFORMATION 3

Outdoor Unit Electronic Expansion Valve (EEV1)

Check Point 1 : Check Connections

- ❑ Check connection of connector (CN111)
(Loose connector or open cable)

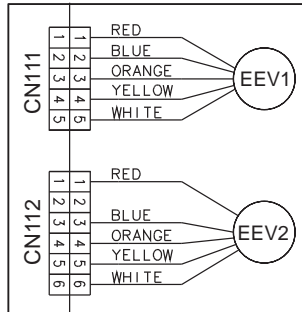

Check Point 2 : Check Coil of EEV

- ❑ Remove connector, check each winding resistance of Coil.

Read wire	Resistance value (68°F)
White - Red	46Ω ± 4Ω
Yellow - Red	
Orange - Red	
Blue - Red	

▶ **If Resistance value is abnormal, replace EEV.**

Check Point 3 : Check Voltage from Controller PCB

- ❑ Remove Connector and check Voltage (DC12V).
>> If it does not appear, replace Controller PCB.



Check Point 4 : Check Noise at start up

- ❑ Turn on Power and check operation noise.
>> If an abnormal noise does not show, replace Controller PCB.

Check Point 5 : Check Opening and Closing Operation of Valve

When Valve is closed, it has a temp. difference between Inlet and Outlet.

CLOSE

Example : Hot GUS Pipe (In)

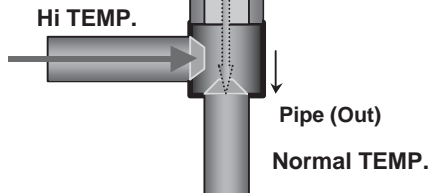

If it is open, it has no temp. difference between Inlet and Outlet.

OPEN

Example : Hot GUS Pipe (In)

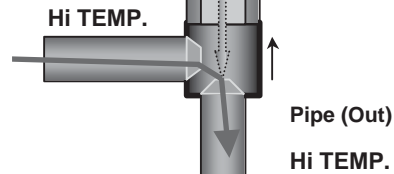

Check Point 6 : Check Strainer

Strainer normally does not have temperature difference between inlet and outlet as shown in (1), but if there is a difference as shown in (2), there is a possibility of inside clogged. In this case, replace Strainer.

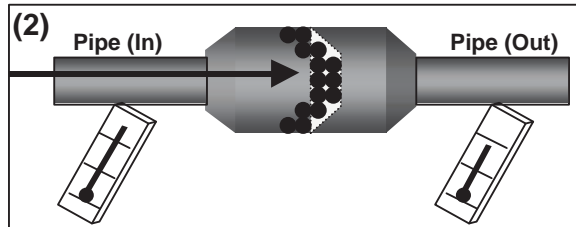
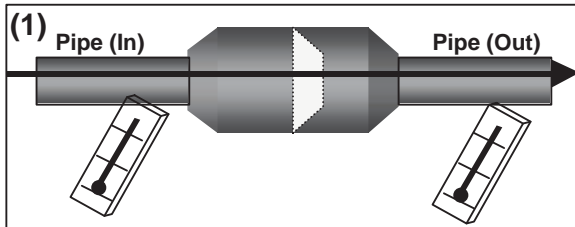

SERVICE PARTS INFORMATION 4

Outdoor Unit Electronic Expansion Valve (EEV2)

Check Point 1 : Check Connections

- ❑ Check connection of connector (CN112)
(Loose connector or open cable)

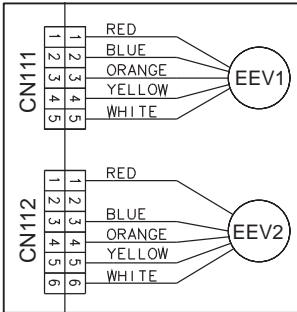

Check Point 2 : Check Coil of EEV

- ❑ Remove connector, check each winding resistance of Coil.

Read wire	Resistance value (68°F)
White - Red	46Ω ± 4Ω
Yellow - Red	
Orange - Red	
Blue - Red	

▶ **If Resistance value is abnormal, replace EEV.**

Check Point 3 : Check Voltage from Controller PCB

- ❑ Remove Connector and check Voltage (DC12V).

>> **If it does not appear, replace Controller PCB.**



Check Point 4 : Check Noise at start up

- ❑ Turn on Power and check operation noise.

>> **If an abnormal noise does not show, replace Controller PCB.**

Check Point 5 : Check Opening and Closing Operation of Valve

When Valve is closed, it has a temp. difference between Inlet and Outlet.

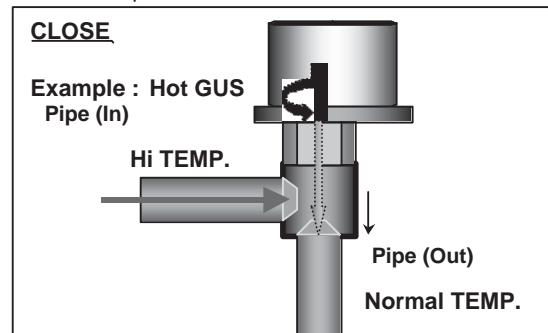

If it is open, it has no temp. difference between Inlet and Outlet.

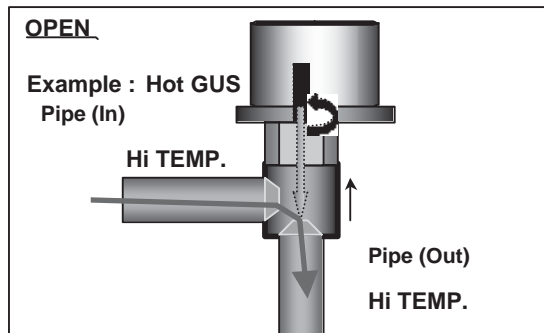

Check Point 6 : Check Strainer

Strainer normally does not have temperature difference between inlet and outlet as shown in (1), but if there is a difference as shown in (2), there is a possibility of inside clogged. In this case, replace Strainer.

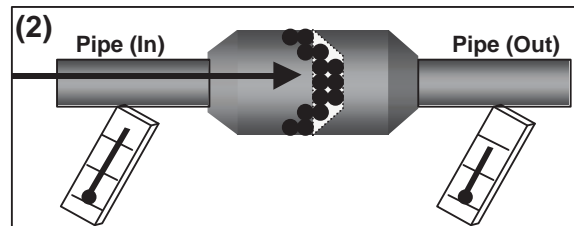
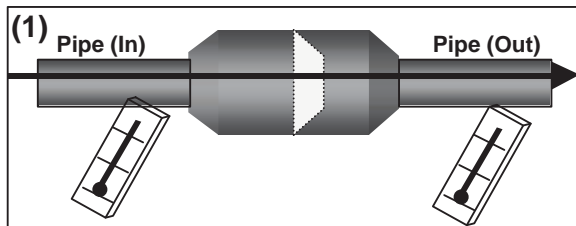

SERVICE PARTS INFORMATION 5

Thermistor

Check Point : Check Thermistor resistance value

□ Remove connector and check Thermistor resistance value.

Temperature [°F]	Resistance Value [kΩ]			
	Thermistor A	Thermistor B	Thermistor C	Thermistor D
- 4	---	---	105.4	---
14	---	27.8	58.2	27.4
23	---	21.0	44.0	20.7
32	168.6	16.1	33.6	15.8
41	129.8	12.4	25.9	12.2
50	100.9	9.6	20.2	9.5
59	79.1	7.6	15.8	7.5
68	62.6	6.0	12.5	5.9
77	49.8	4.8	10.0	4.7
86	40.0	3.8	8.0	3.8
104	26.3	2.5	5.3	2.5
122	17.8	1.7	3.6	1.7
140	12.3	1.2	---	1.2
158	8.7	---	---	0.8
176	6.3	---	---	0.6
194	4.6	---	---	0.4
212	3.4	---	---	0.3
230	2.6	---	---	---
248	2.0	---	---	---
Applicable Thermistors	Discharge temp. TH Comprssor temp. TH	Heat exchanger. TH Suction temp. TH Sub-cool heat exchanger LP gas (inlet) TH Sub-cool heat exchanger LP gas (outlet) TH Sub-cool heat exchanger HP liquid (outlet) TH	Outdoor temp. TH	Heat sink temp. TH

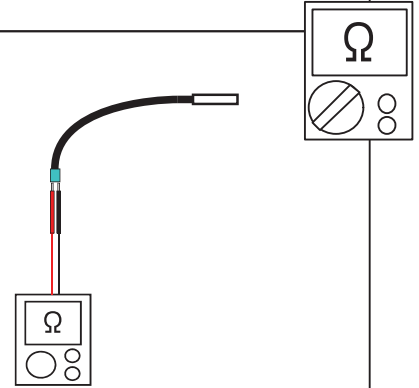

SERVICE PARTS INFORMATION 6

Discharge Pressure Sensor Suction Pressure Sensor

1. Discharge Pressure Sensor

Check Point : Check Voltage from Main PCB

- With the connector connected to the PCB, measure the voltage between CN91:3-4 of the Main PCB.

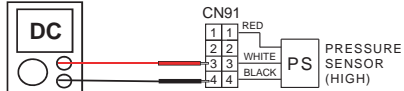

- Characteristics of pressure sensor

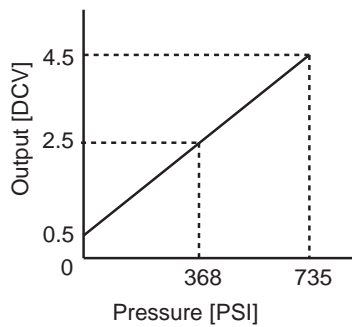

2. Suction Pressure Sensor

Check Point : Check Voltage from Main PCB

- With the connector connected to the PCB, measure the voltage between CN92:2-3 of the Main PCB.

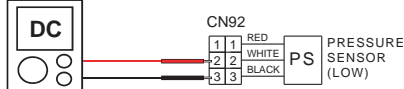

- Characteristics of pressure sensor

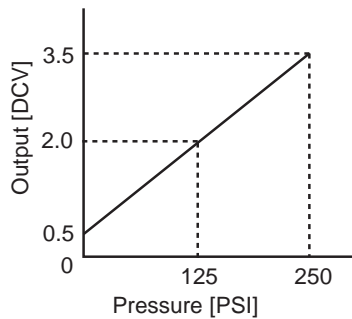

SERVICE PARTS INFORMATION 7

Outdoor Fan Motor

Check Point 1 : Check rotation of Fan

- Rotate the fan by hand when operation is off.
(Check if fan is caught, dropped off or locked motor)
- >>If Fan or Bearing is abnormal, replace it.**

Check Point 2 : Check resistance of Outdoor fan motor

- Refer to below. Circuit-test "Vm" and "GND" terminal.
(Vm: DC voltage, GND: Earth terminal)
- >>If they are short-circuited (below 300 kΩ), replace Outdoor fan motor and Main PCB.**

Pin number (wire color)	Terminal function (symbol)
1 (Red)	DC voltage (Vm)
2	No function
3	No function
4 (Black)	Earth terminal (GND)
5 (White)	Control voltage (Vcc)
6 (Yellow)	Speed comand (Vsp)
7 (Brown)	Feed back (FG)

SERVICE PARTS INFORMATION 8

Active Filter Module

Check Point 1 : Check Open or Short-circuit and Diode

- Remove connector, check the open or short-circuit and the diode in the module

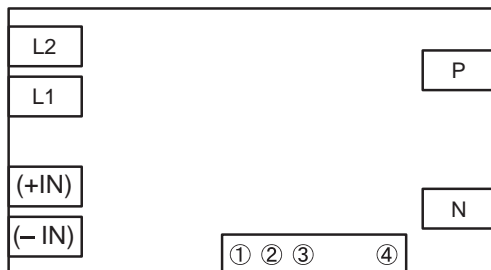

Check the open or short-circuit

Terminal		Resistance value
Tester(+)	Tester(-)	
(+IN)	(-IN)	360kΩ ± 20%
(-IN)	N	0 Ω
P	(+IN)	900kΩ ± 20%
L1	L2	2.03MΩ±20% / 4.83MΩ±20% (Ref. value 1) (Ref. value 2)
P	N	540kΩ ± 20%
L1,L2	Control Box	∞ Ω
L2	N	1.69MΩ±20% / 1.23MΩ±20% (Ref. value 1) (Ref. value 2)

Check the diode

Terminal		Resistance value
Tester(+)	Tester(-)	
L2	P	1.12MΩ±20% / 504kΩ±20% (Ref. value 1) (Ref. value 2)
P	L2	2.23MΩ±20% / 503kΩ±20% (Ref. value 1) (Ref. value 2)

Ref. value 1
 Specifications for Multimeter
 Manufacturer : FLUKE
 Model name : FLUKE11
 Power source : DC9V.

Ref. value 2
 Specifications for Multimeter
 Manufacturer : Sanwa
 Model name : PM3
 Power source : DC3V.

► **If it is abnormal,replace ACTIVE FILTER MODULE**

Check Point 2 : Check the Output DC voltage (between P and N)

- Check the Output DC voltage (between P and N) of compressor stopping and operating.
 - >> If the output voltage of compressor operating is less than the output voltage of compressor stopping, Active Filter Module is defective. >> **Replace Active Filter Module**

SERVICE PARTS INFORMATION 10
Diode Bridge (on the Inverter PCB)

Check Point 1: Check OPEN / SHORT of Diode Bridge

• Remove each terminal, and check open / short of the Diode Bridge.

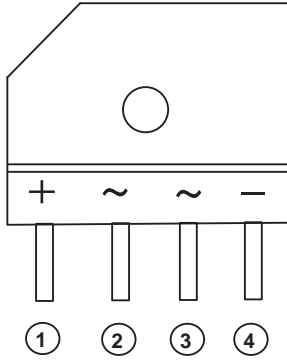

(+), (-) shows the terminal of the meter

Read wire		Resistance Value
① pin (-)	② Pin (+)	1MΩ greater
	③ Pin (+)	
④ pin (+)	② Pin (-)	
	③ Pin (-)	

▶ **If it is abnormal, replace Inverter PCB**

Hybrid Flex Inverter System

3 . DISASSEMBLY PROCESS

3-1 . DISASSEMBLY PROCESS for Outdoor Unit

⚠ WARNING

Before servicing the unit, turn the power supply switch OFF,
Then, do not touch electric parts for 10 minutes due to the risk of electric shock.

1. Appearance



2. SERVICE PANEL removal

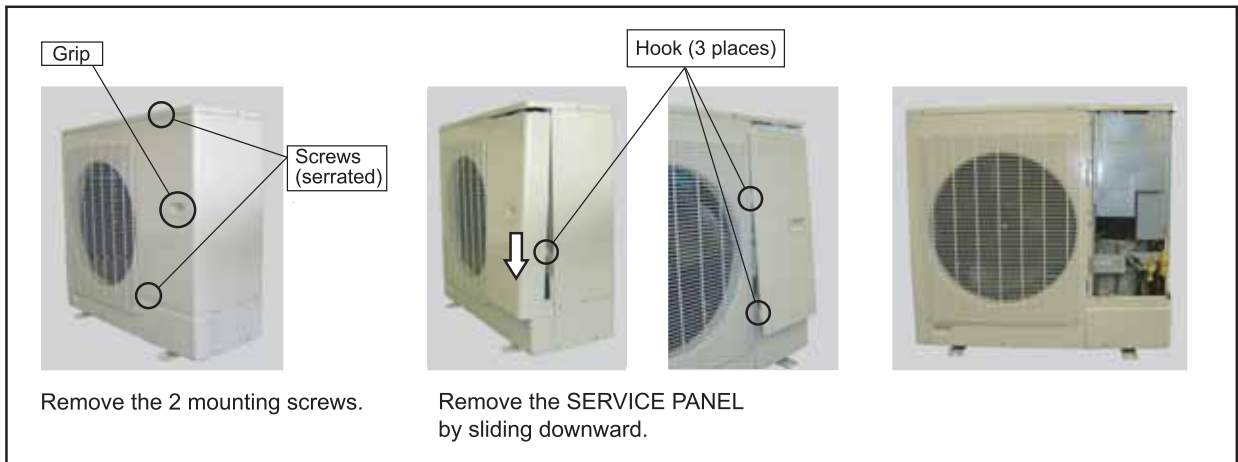

3. COVER(FRONT) removal

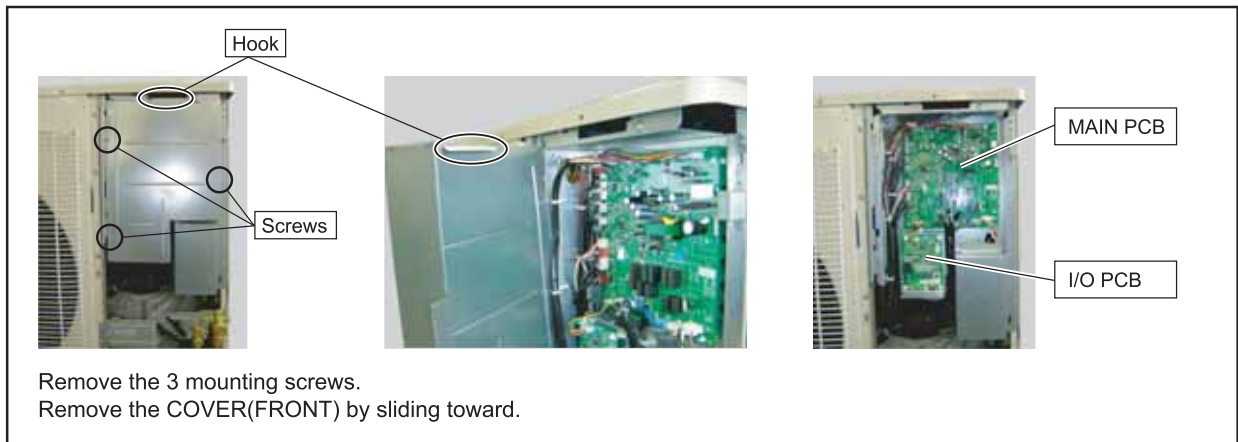

4. COVER(TERMINAL) removal

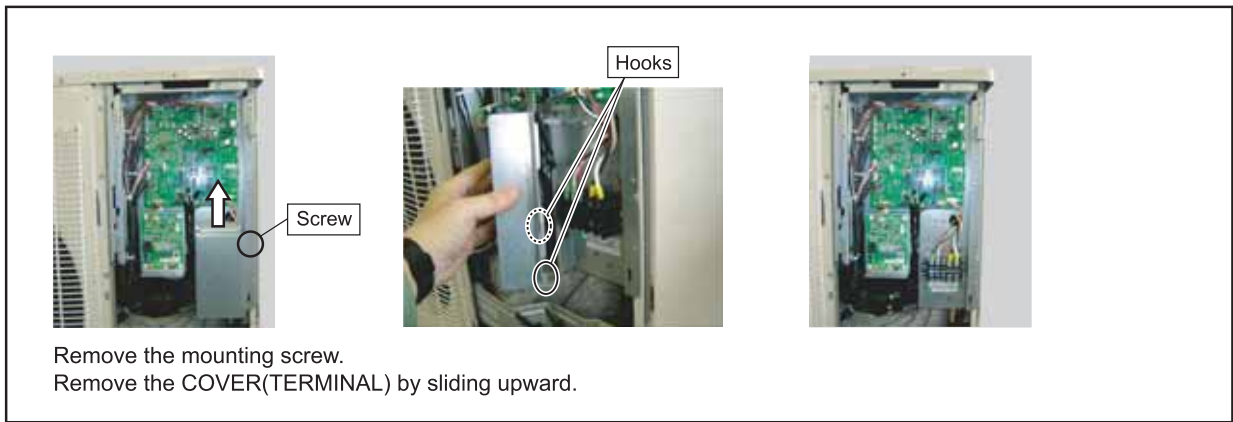

5. MAIN PCB removal

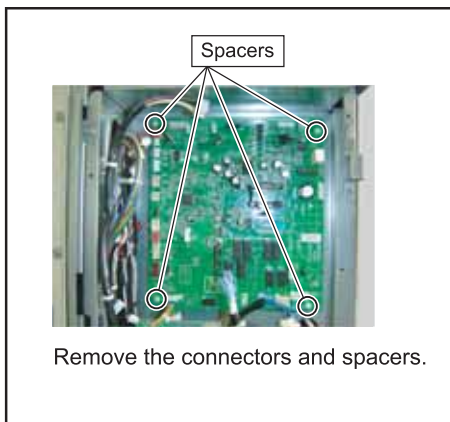

6. I/O PCB removal

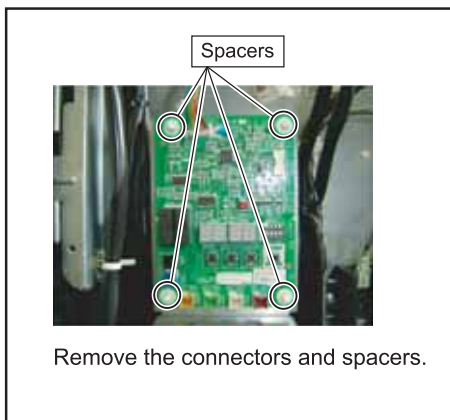

7. INVERTER PCB, POWER SUPPLY PCB and Active Filter Module removal

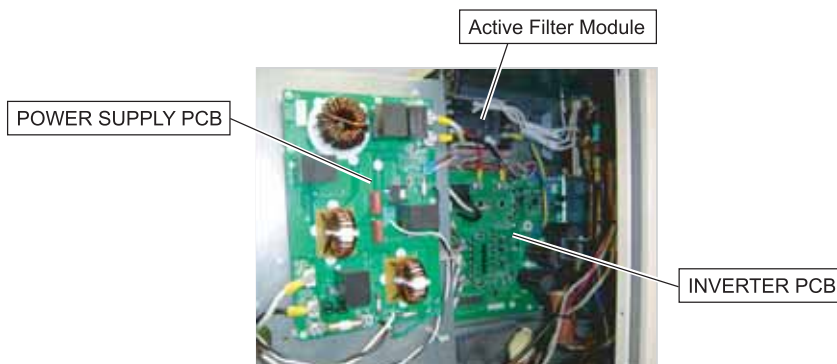
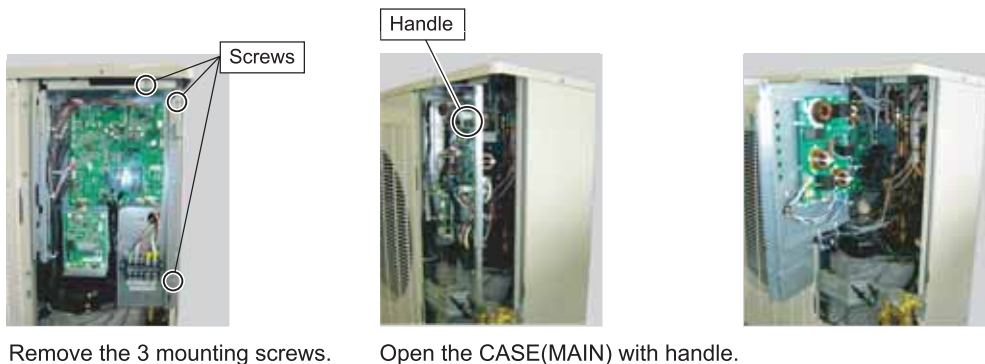

7-1. POWER SUPPLY PCB removal

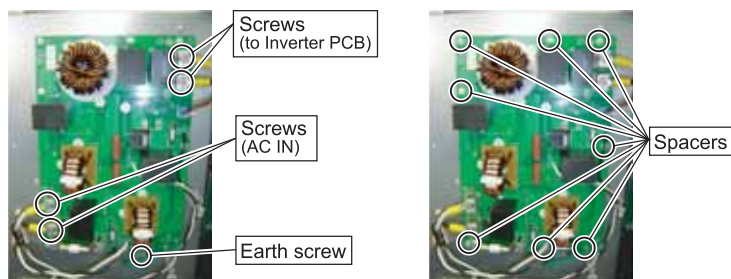

Remove the connector and screws.

Note the tightening torque at the installation.
Tightening torque is $2.5 \pm 0.2 \text{ N}\cdot\text{m}$ (except for the earth screw)

Remove the spacers. (8 places)

7-2. INVERTER PCB removal

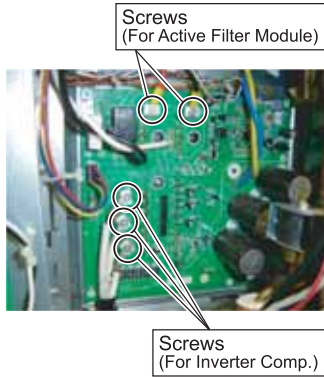

Remove the 5 mounting screws and wires.

Note the tightening torque at the installation.
Tightening torque is 2.5 ± 0.2 N·m.

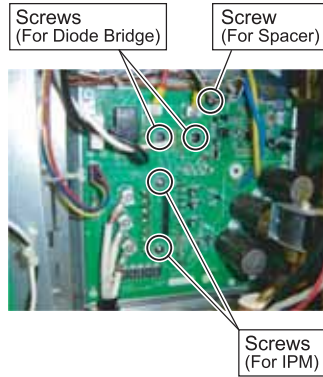

Remove the 5 mounting screws.

For screws of IPM and Spacer,
Note the tightening torque at the installation.
1. Temporary tightening : 0.2 to 0.4N·m.
2. Final tightening : 0.98 to 1.47N·m.

For screws of Diode Bridge,
Note the tightening torque at the installation.
1. Temporary tightening : 0.2 to 0.4N·m.
2. Final tightening : 0.5 to 0.8N·m.

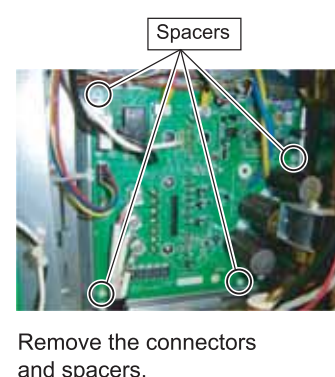

Remove the connectors and spacers.

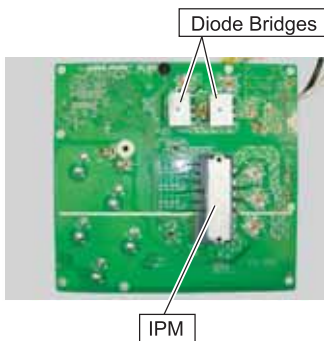

Spread the Heat Transfer Compound on the other side of IPM and Diode Bridges when you exchange INVERTER PCB by the repair.

Specifications for the Heat Transfer Compound

- Manufacturer : Shin-Etsu Chemical Co.,Ltd.
- Grade : G746
- Manufacturer : Dow Corning Toray Co.,Ltd.
- Grade : SC102

7-3. Active Filter Module removal

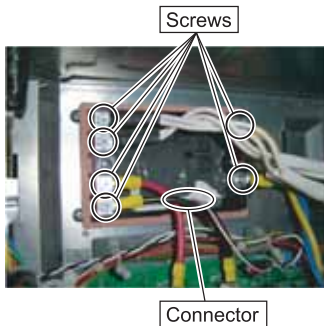

Remove the 6 mounting screws and wires.

Remove the connector.

Note the tightening torque at the installation.
Tightening torque is 1.27 to 1.47N·m.

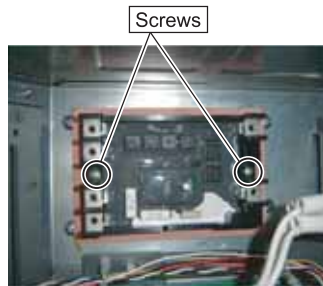

Remove the 2 mounting screws.

Note the tightening torque at the installation.
1. Temporary tightening : 0.2 to 0.4N·m.
2. Final tightening : 0.6 to 0.9N·m.



Spread the Heat Transfer Compound on the other side of Active Filter Module when you exchange Active Filter Module by the repair.

Specifications for the Heat Transfer Compound

- Manufacturer : Shin-Etsu Chemical Co.,Ltd.
- Grade : G746
- Manufacturer : Dow Corning Toray Co.,Ltd.
- Grade : SC102

8. COIL CHOKE, PRESSURE SENSOR, and SOLENOID COIL removal

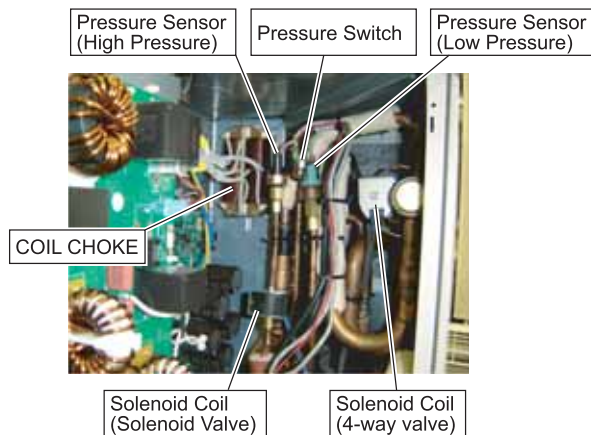

8-1. COIL CHOKE removal

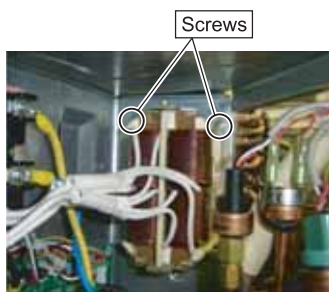

Remove the wires from the terminal of Active Filter Module.
Remove the 2 mounting screws.



Remove the COIL CHOKE by sliding upward.

8-2. PRESSURE SENSOR removal

⚠ CAUTION

Wear gloves to prevent the frostbite, because a small amount of refrigerant leaks during work.



Cut the binders.
(6 places)



Remove the PRESSURE SENSOR with wrench.
Note the tightening torque at the installation.
Tightening torque is $15 \pm 1.5 \text{ N}\cdot\text{m}$.

8-3. SOLENOID COIL (4way valve) removal



Remove the mounting screw.



Remove the SOLENOID COIL.

Note at the installation.
Bind all wires with binders (cable ties) at the location shown in the picture of "WIRING MANUAL".

8-4. SOLENOID COIL (Solenoid valve) removal



Remove the mounting screw.



Remove the SOLENOID COIL.

Note at the installation.
Bind all wires with binders (cable ties) at the location shown in the picture of "WIRING MANUAL".

9. EEV COIL removal



Remove the EEV COIL by hand.

Note at the installation.
Bind all wires with binders (cable ties) at the location shown in the picture of "WIRING MANUAL".

10. THERMISTOR removal



Remove the THERMISTOR SPRING.



Remove the THERMISTOR.

Note at the installation.
Bind all wires with binders (cable ties) at the location shown in the picture of "WIRING MANUAL".

11. FAN MOTOR removal

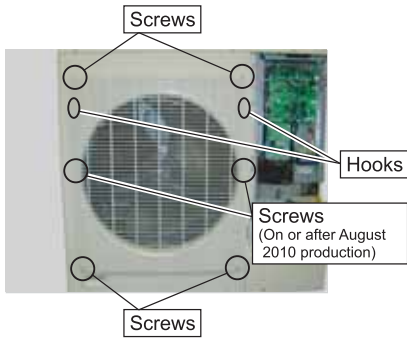

Remove the 4 mounting screws.
 (On or after August 2010 production)
 Remove the 6 mounting screws.

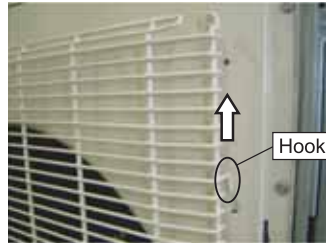

Remove the FAN GUARD
 by sliding upward.



Remove the nut.
 And remove the PROPELLER FAN.
 Note at the installation.
 Insert propeller Fan and Moter shaft reference
 D cutting position.
 And the tightening torque at the installation.
 Tightening torque is from 10 to 12N-m.

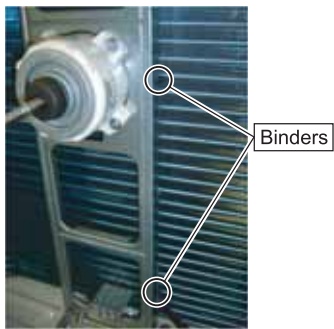

Cut the binders. (2 places)

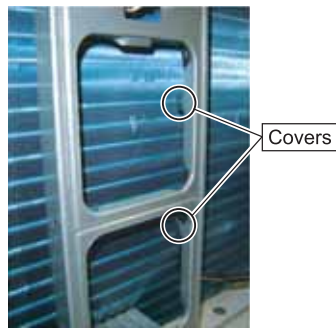

Open the covers. (2 places)



Loose the clamp, and
 remove the lead wires.



Remove the 4 mounting screws.

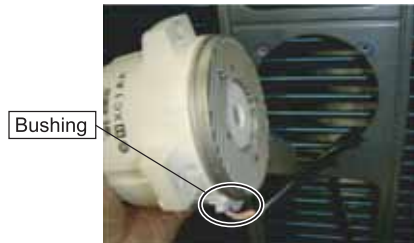

Remove the FAN MOTOR.
 Note at the installation.
 The position of the bushing must be downward.

12. TOP PANEL removal

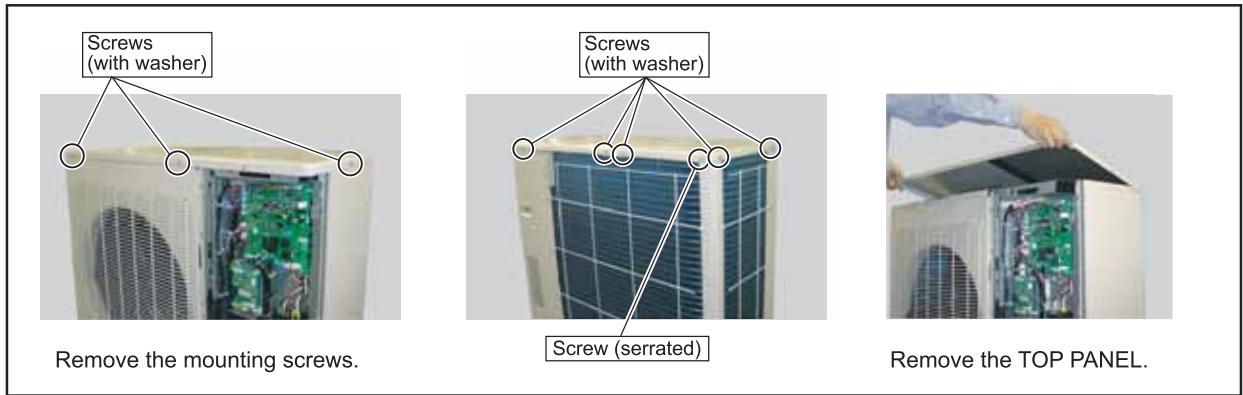

13. PIPE COVER FRONT removal

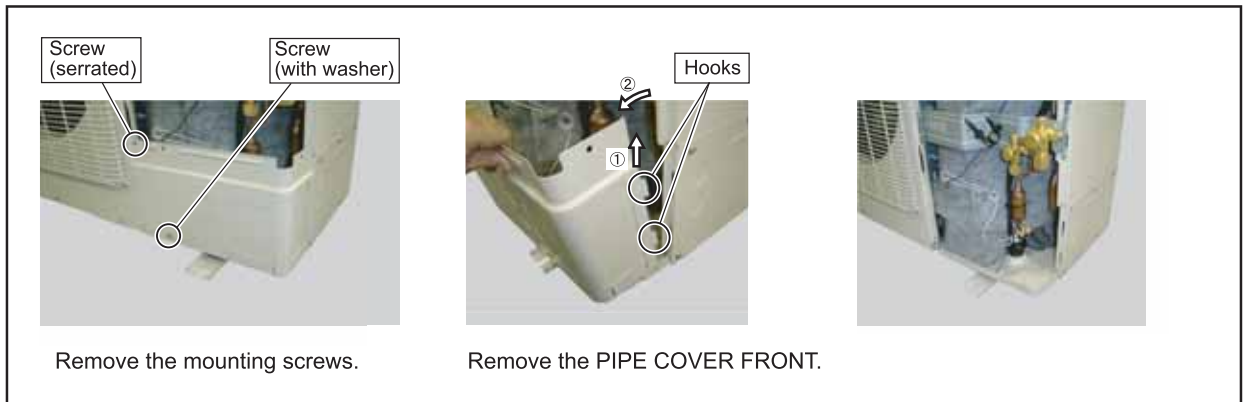

14. RIGHT PANEL removal

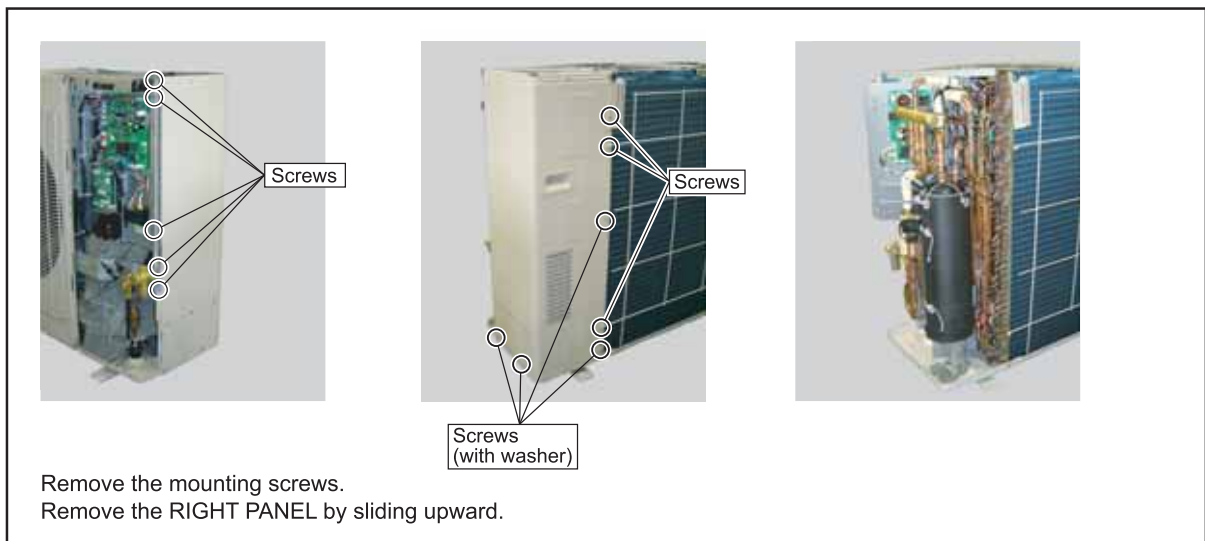

15. COMPRESSOR removal

Precautions for exchange of Compressor.

Do not allow moisture or debris to get inside refrigerant pipes during work.

Procedure for compressor removal.

- (1) Turn off power.
- (2) Remove the SERVICE PANEL.
- (3) Fully close the 3WAY VALVE(GAS) and 3WAY VALVE(LIQUID).
- (4) Collect the refrigerant from the 3WAY VALVE.

Start the following work after completely collecting the refrigerant.
Do not reuse the refrigerant that has been collected.



Remove the 8 mounting screws.

Remove the VALVE PLATE.



Remove the THERMISTOR SPRING
with the THERMISTOR (Compressor temp.)

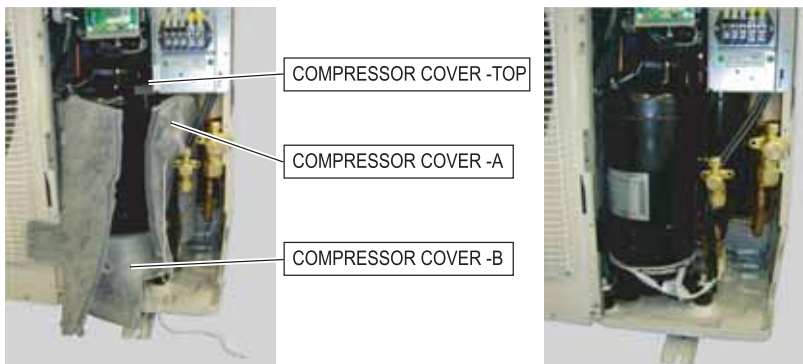

Remove the
COMPRESSOR COVER-A, -B, and -TOP

Thermistor (Discharge)

Cut the binder, and remove the heat insulation.

Remove the Thermistor(Discharge).

Hook

Loose the HEATER (CRANK CASE).

HEATER (CRANK CASE)

Remove the COMP BOLTS.
(3 places)

Range

Cut the Discharge pipe in this range.

Range

Cut the Suction pipe in this range.
Remove the COMPRESSOR.

Caution

- Keep their shape better.
- There is a possibility of catching fire to oil when removing by the welding without cutting it.

Procedure for compressor installation.

Reverse procedure to removing the compressor.

Precautions for installation of Compressor.

- (1) When brazing, do not apply the flame to the terminal.
- (2) When brazing, be sure to replace the air in the pipe with nitrogen gas to prevent forming oxidization scale.

16. Precautions for exchange of refrigerant-cycle-parts

- (1) During exchange the following parts shall be protected by wet rag and not make the allowable temperature or more.
- (2) Remove the heat insulation when there is the heat insulation near the welding place.
Move and cool it when its detaching is difficult.
- (3) Cool the parts when there are parts where heat might be transmitted besides the replacement part.
- (4) Interrupt the flame with the fire-retardant board when the flame seems to hit the following parts directly.
- (5) Do not allow moisture or debris to get inside refrigerant pipes during work.
- (6) When brazing, be sure to replace the air in the pipe with nitrogen gas to prevent forming oxidization scale.

Part name	Allowable temperature	Precautions in work
SOLENOID VALVE	248°F	Remove the coil before brazing. And install the coil after brazing.
EXPANSION VALVE	248°F	Remove the coil before brazing. And install the coil after brazing.
4WAY VALVE	248°F	Remove the suction temp. sensor before brazing. And install the suction temp. sensor after brazing.
3WAY VALVE (GAS)	248°F	
3WAY VALVE (LIQUID)		
UNION JOINT	212°F	Remove the pressure sensor before brazing. And install the pressure sensor after brazing.
PRESSURE SENSOR	212°F	Tighten the flare part gripping it. (Tightening torque :15±1.5N·m) Do the static electricity measures.
PRESSURE SWITCH	212°F	

APPLICABLE MODEL AOJ48RLXFZ
AO*G45LAT8
ROG45LAT8
HOG45LAT8

Bind all wires with binders (cable ties) at the location shown in the picture of this manual.

CAUTION

If replacing a component/part, bind all wire with cable ties. Loose wires may come in contact with PCB and overheat causing electric shock or fire.

PARTS LIST

※The following list is the necessary quantity of Binders (cable ties) for each service parts replacement.

WIRE	SURVICE PARTS	ATTACHED WIRE	Q'ty	BINDER (Q'ty)			MANUAL
				small size (80mm)	middle size (150mm)	large size (200mm)	
a	THERMISTOR ASSY A(SERVICE) 9380229001	THERMISTOR ASSEMBLY 9900599003	1	3	7	0	WIRING MANUAL 9380230007
b	THERMISTOR(HEX) ASSY(SERVICE) 9380229032	HEAT EXCHANGER THERMISTOR 9900600006	1	0	7	0	
c	THERMISTOR(OUT) ASSY(SERVICE) 9380229049	THERMISTOR(OUTDOOR TEMP) 9900210052	1	2	6	0	
d	SENSOR ASSY A(SERVICE) 9380229056	SENSOR 9900505059	1	0	6	0	
e	SENSOR ASSY B(SERVICE) 9380229063	SENSOR 9900505066	1	0	6	0	
f-1	SOLENOID ASSY A(SERVICE) 9380229094	SOLENOID 9970109010	1	0	2	0	
f-2	SOLENOID ASSY C(SERVICE) 9380229131	SOLENOID 9900189228	1				
g	SOLENOID ASSY B(SERVICE) 9380229100	SOLENOID 9970055072	1	0	2	0	
h-1	HTR(CRANK) ASSY(SERVICE) 9380229117	HEATER(CRANK CASE) 9900132088	1	0	3	1	
h-2	BELT HEATER ASSY(SERVICE) 9380229124	BELT HEATER 9361140301	1				
i	THERMISTOR ASSY B(SERVICE) 9380229018	THERMISTOR ASSEMBLY 9900599010	1	2	6	0	
j	THERMISTOR ASSY C(SERVICE) 9380229025	THERMISTOR ASSEMBLY 9900598006	1	0	6	0	
k	COIL(EXP VLV)ASSY A(SERVICE) 9380229070	COIL(EXPANSION VALVE) 9970098031	1	0	4	0	
l	COIL(EXP VLV)ASSY B(SERVICE) 9380229087	COIL(EXPANSION VALVE) 9970096068	1	0	4	0	

※f-1 : SOLENOID ASSY A is applied only to the following models
[AOJ48RLXFZ]/[AOBG45LAT8]

※h-1 : HTR(CRANK) ASSY is applied only to the following model
[AOJ48RLXFZ]

※f-2 : SOLENOID ASSY C is applied only to the following models
[AOYG45LAT8]/ [AOHG45LAT8]/[ROG45LAT8]/[HOG45LAT8]

※h-2 : BELT HEATER ASSY is applied only to the following models
[AOYG45LAT8]/ [AOHG45LAT8]/ [AOBG45LAT8]
/[ROG45LAT8]/[HOG45LAT8]

CHANGE BINDER LIST

When changing parts, the following Binder Numbers shown in the picture must be replaced at the same location.

WIRE	SURVICE PARTS	REMARK	change BINDER NO.		
			small size	middle size	large size
a	THERMISTOR ASSY A(SERVICE) 9380229001	TAPE COLOR : RED / NO MARK (2 WIRES 1 CONNECTOR)	4,6,7	5,10,12,13,14,15,18	
b	THERMISTOR(HEX) ASSY(SERVICE) 9380229032	TAPE COLOR : WHITE		3,10,12,13,14,15,18	
c	THERMISTOR(OUT) ASSY(SERVICE) 9380229049	OUTDOOR TEMP	1,2	10,12,13,14,15,18	
d	SENSOR ASSY A(SERVICE) 9380229056	CONNECTOR : WHITE		10,12,13,14,16,18	
e	SENSOR ASSY B(SERVICE) 9380229063	CONNECTOR : RED		10,12,13,14,16,18	
f-1	SOLENOID ASSY A(SERVICE) 9380229094	CONNECTOR : BLUE		11,19	
f-2	SOLENOID ASSY C(SERVICE) 9380229131	CONNECTOR : BLUE			
g	SOLENOID ASSY B(SERVICE) 9380229100	CONNECTOR : WHITE		11,17	
h-1	HTR(CRANK) ASSY(SERVICE) 9380229117	HEATER(CRANK CASE) (2 WIRES)		11,19,23	28
h-2	BELT HEATER ASSY(SERVICE) 9380229124	CONNECTOR : BLUE			
i	THERMISTOR ASSY B(SERVICE) 9380229018	TAPE COLOR : BLUE / YELLOW (2 WIRES 1 CONNECTOR)	8,9	10,18,20,22,24,25	
j	THERMISTOR ASSY C(SERVICE) 9380229025	TAPE COLOR : BROWN / GRAY (2 WIRES 1 CONNECTOR)		10,18,20,22,26,27	
k	COIL(EXP VLV)ASSY A(SERVICE) 9380229070	CONNECTOR : RED		10,18,20,21	
l	COIL(EXP VLV)ASSY B(SERVICE) 9380229087	CONNECTOR : WHITE		10,18,20,21	
m	WIRE(PRESSURE) SW	CONNECTOR : RED (2 WIRES)		10,12,13,14,16,18	

※m : WIRE(PRESSURE SW) are not service parts.

FRONT VIEW (MAIN BOARD SIDE)

Please refer to below picture and attached table.
 Please remove the binders where necessary and replace the wires.
 ※We have removed the "Right panel" when taking the pictures.

APPLICABLE MODEL : **[AO*G45LAT8]**
[ROG45LAT8]
[HOG45LAT8]

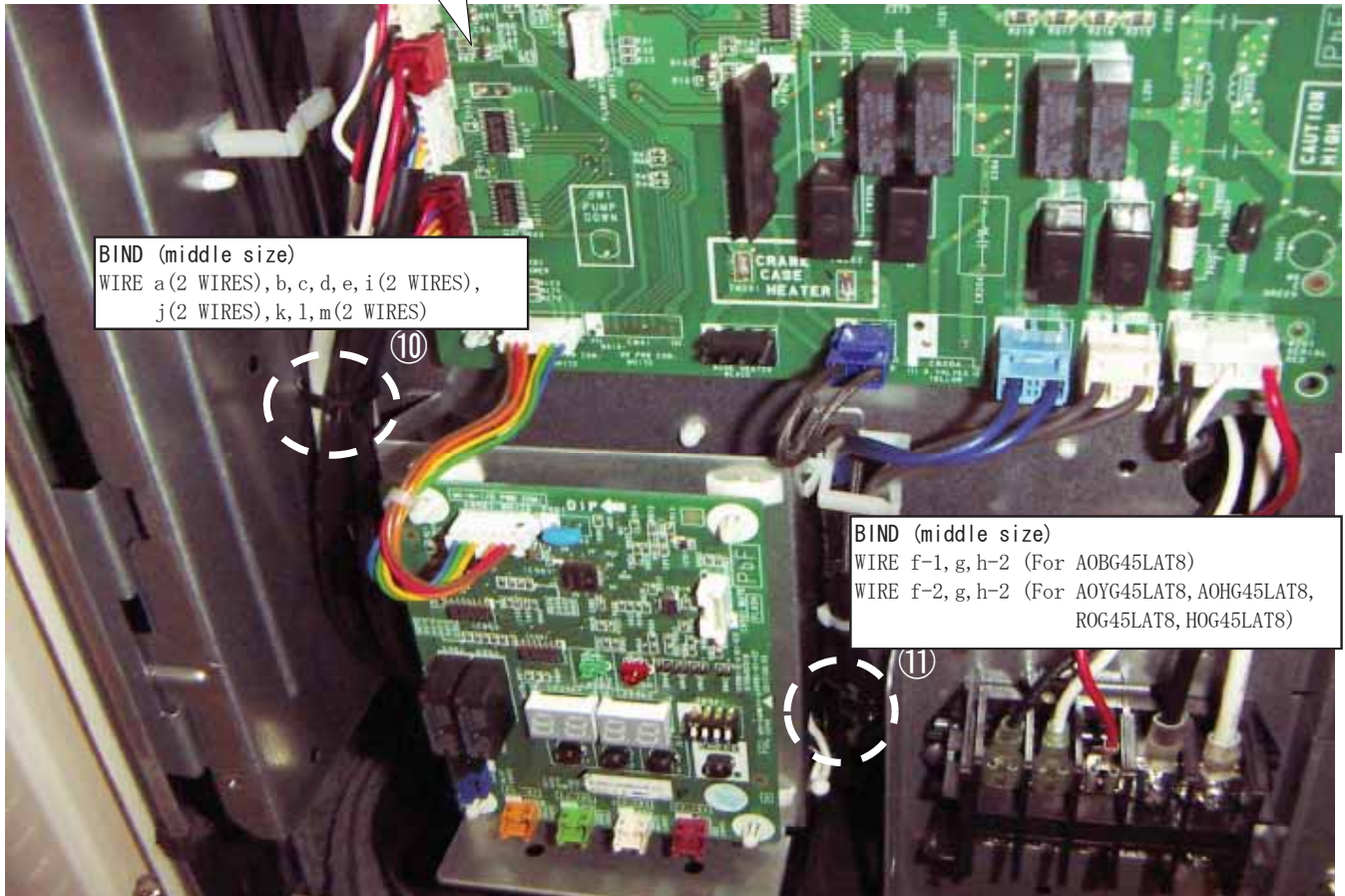
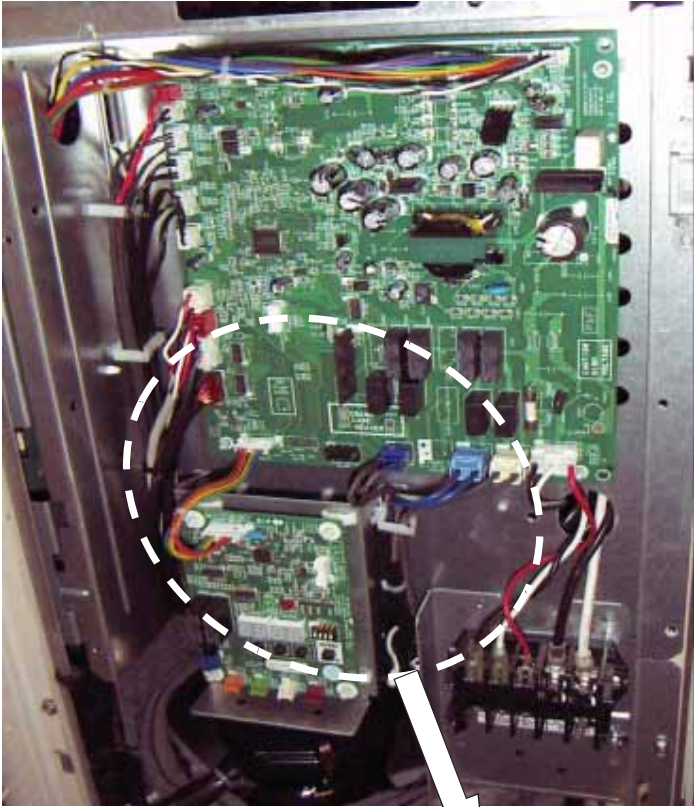

BACK VIEW

APPLICABLE MODEL: ALL MODEL

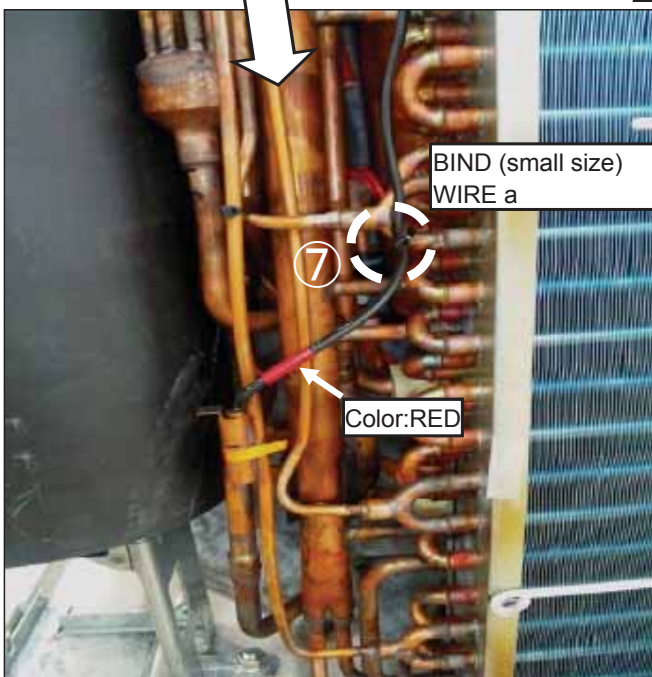
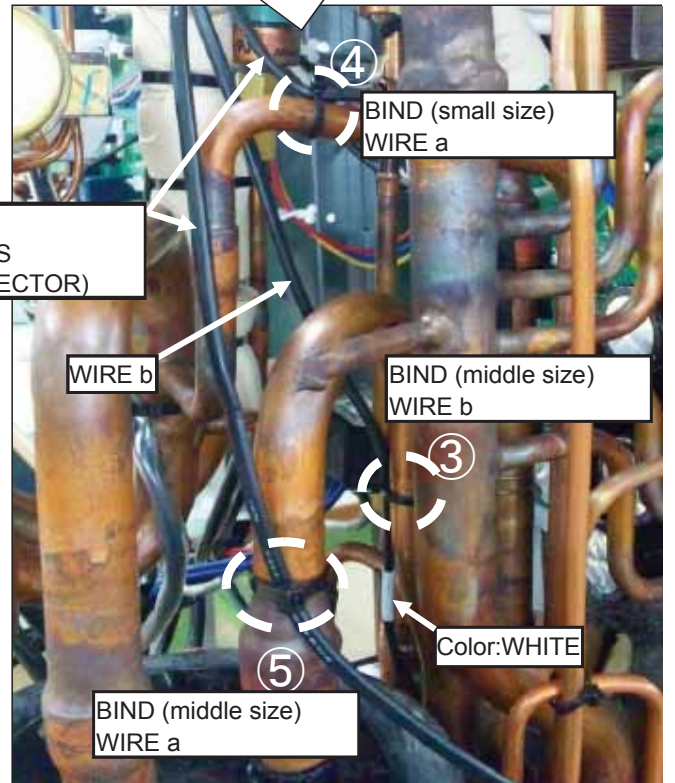
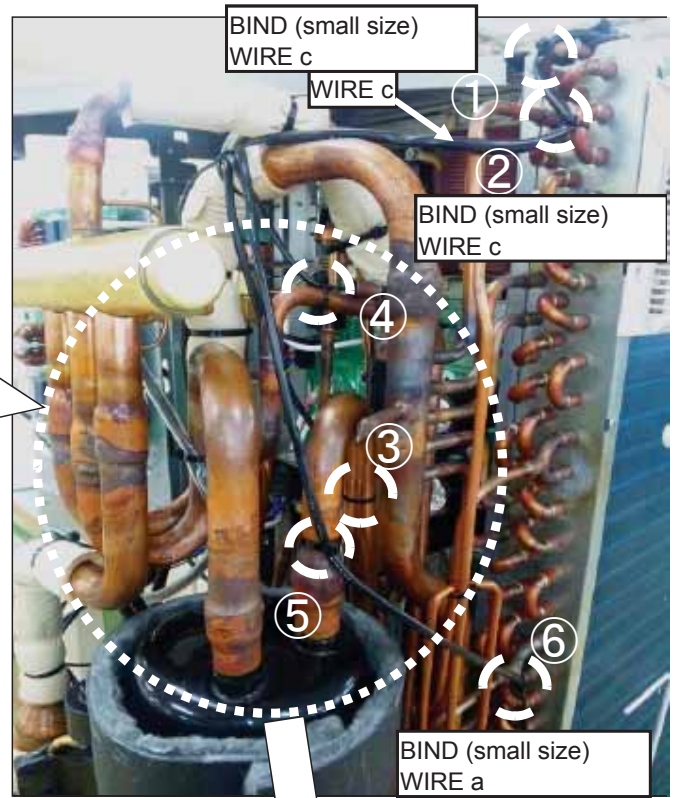
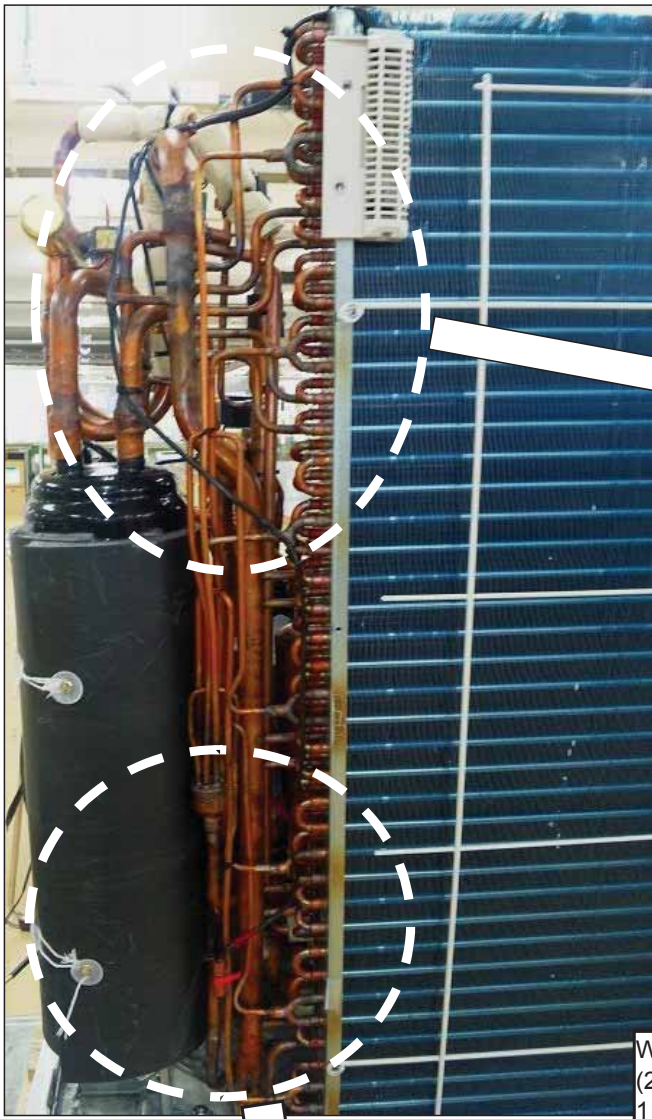

WIRE a
(2 WIRES
1 CONNECTOR)

※We have removed the "Right panel" when taking the pictures.

FRONT VIEW

APPLICABLE MODEL: ALL MODEL

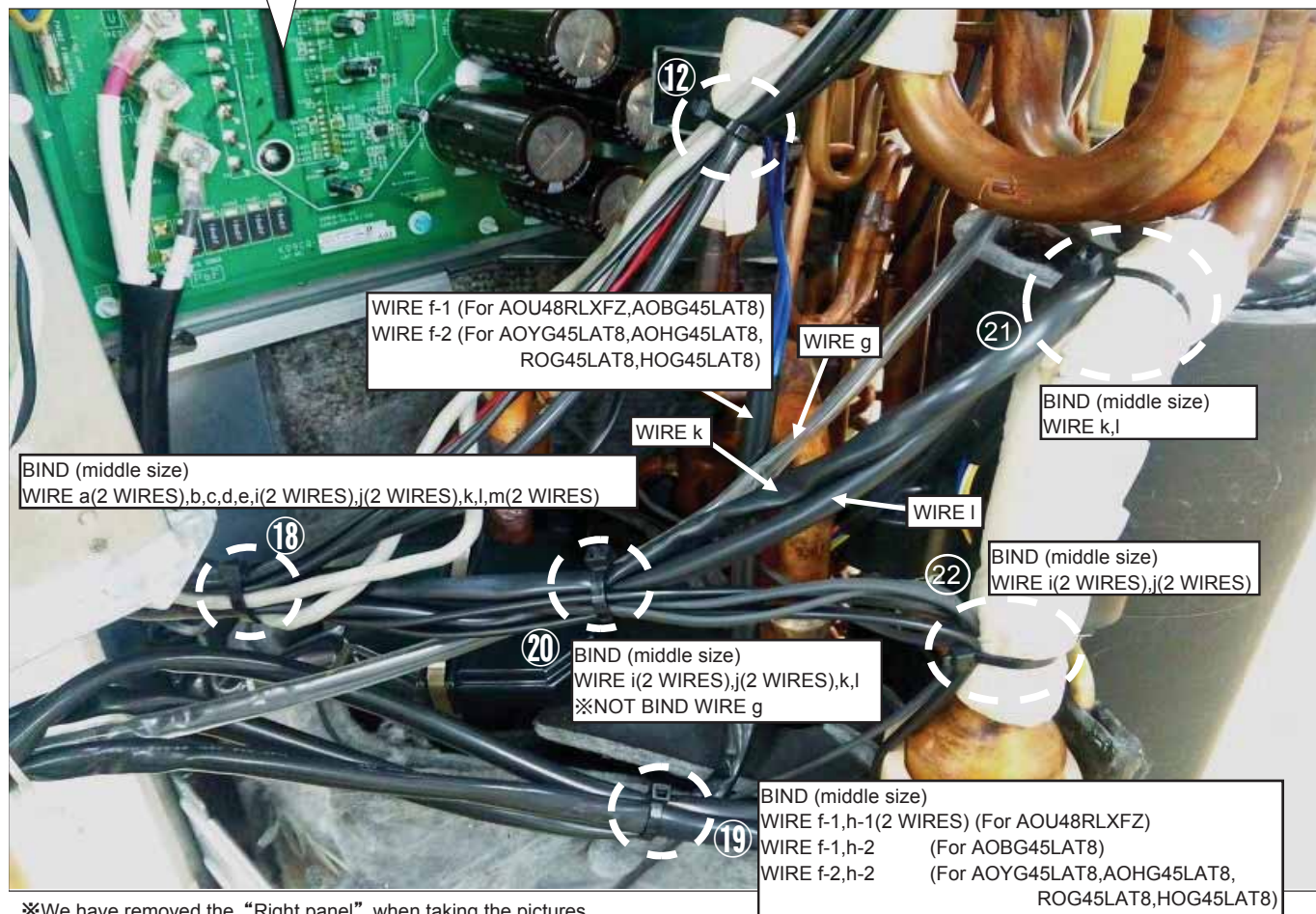
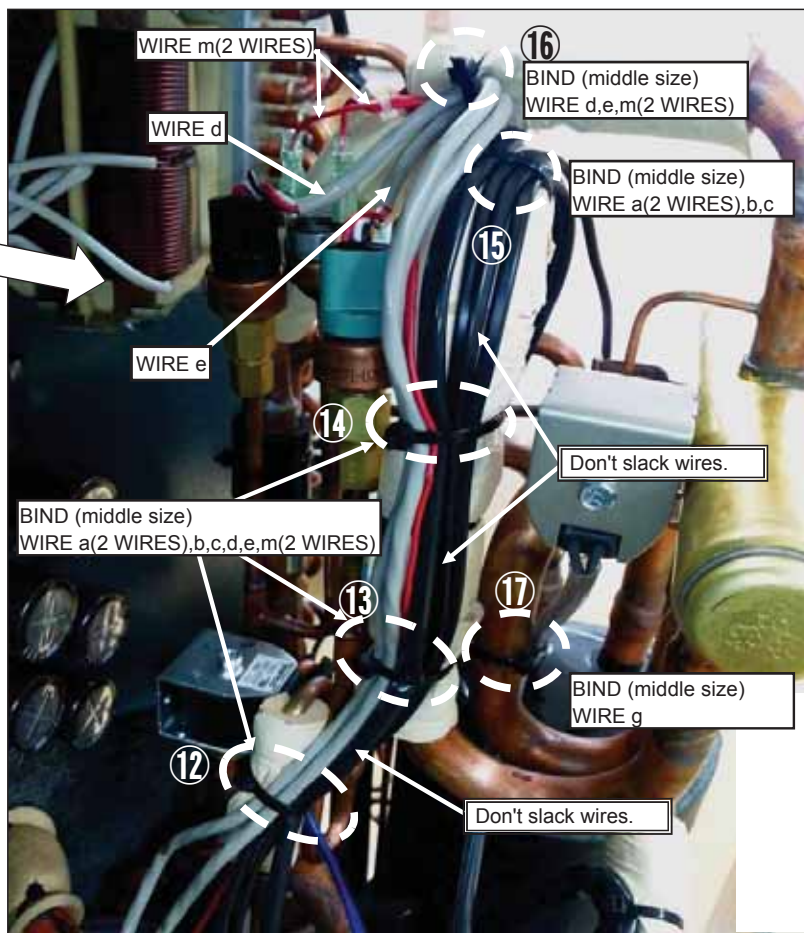
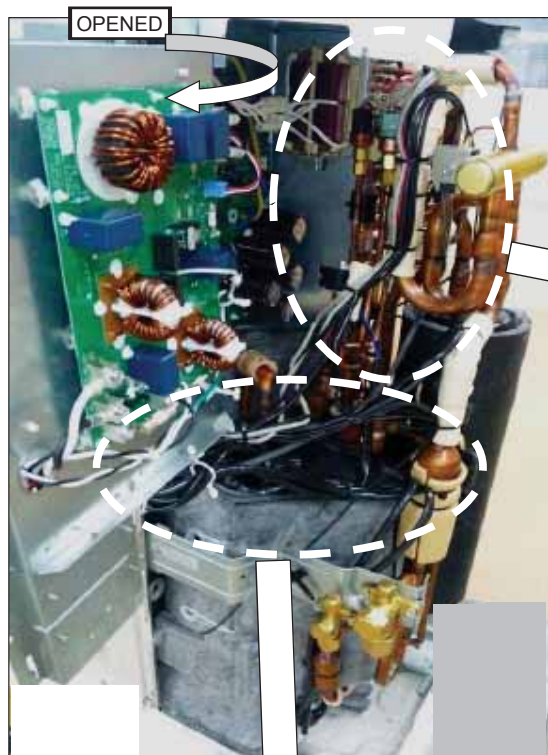

※We have removed the "Right panel" when taking the pictures.

APPLICABLE MODEL: ALL MODEL

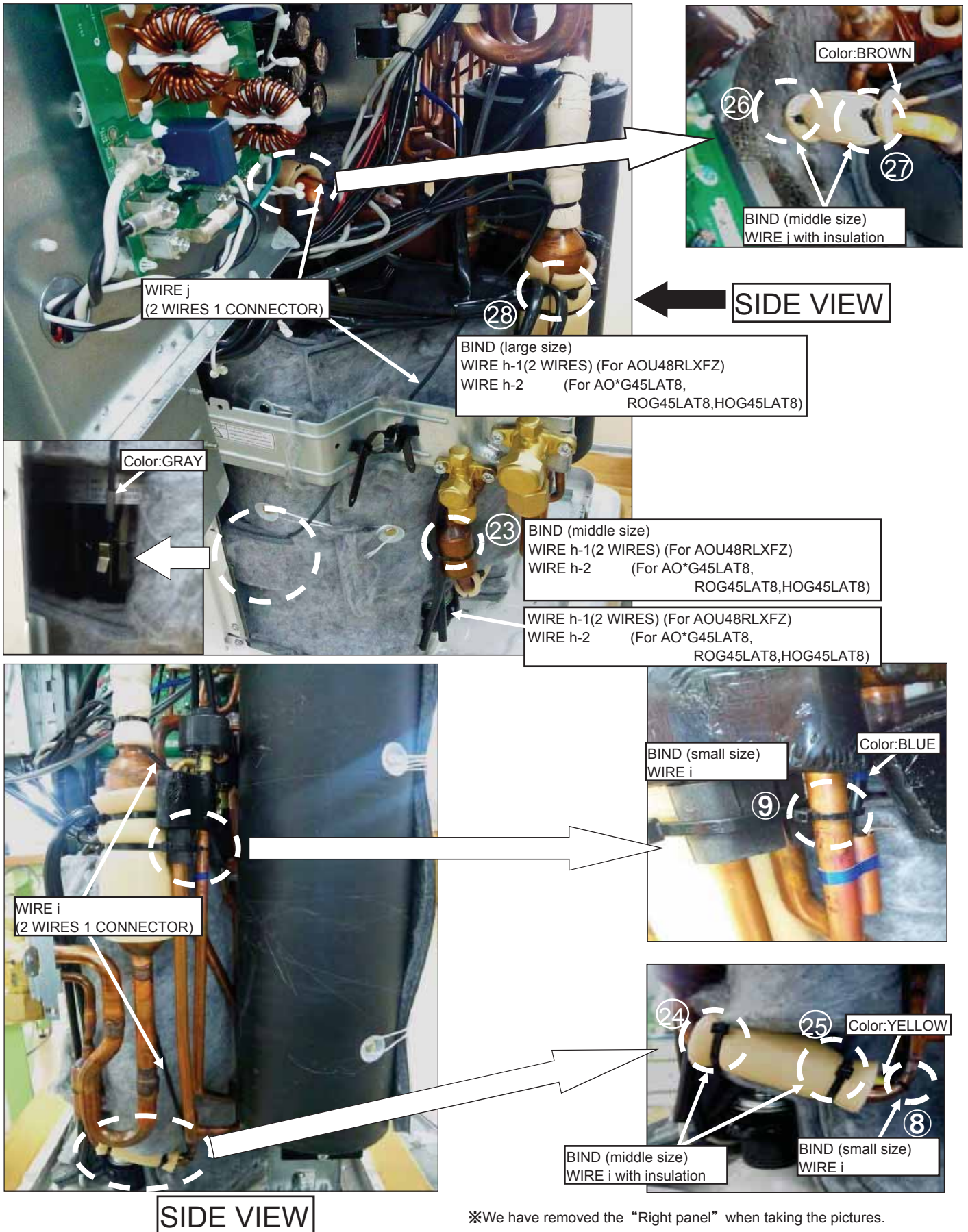

※We have removed the "Right panel" when taking the pictures.

3-2. DISASSEMBLY PROCESS for Branch Box

⚠ WARNING

Before servicing the unit, turn the power supply switch OFF,
Then, do not touch electric parts for 10 minutes due to the risk of electric shock.

1. Appearance



2. CONTROLLER BOX COVER removal



3. CONTROLLER PCB removal

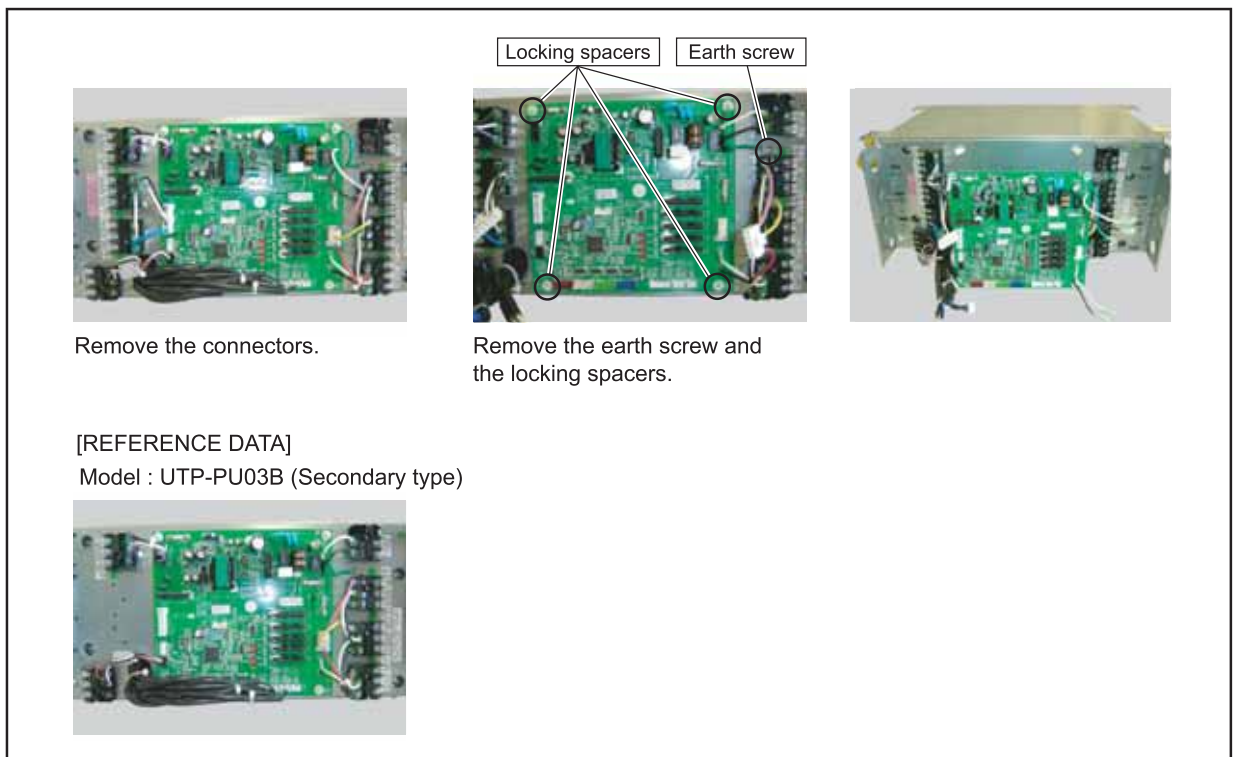

4. BOTTOM PANEL removal

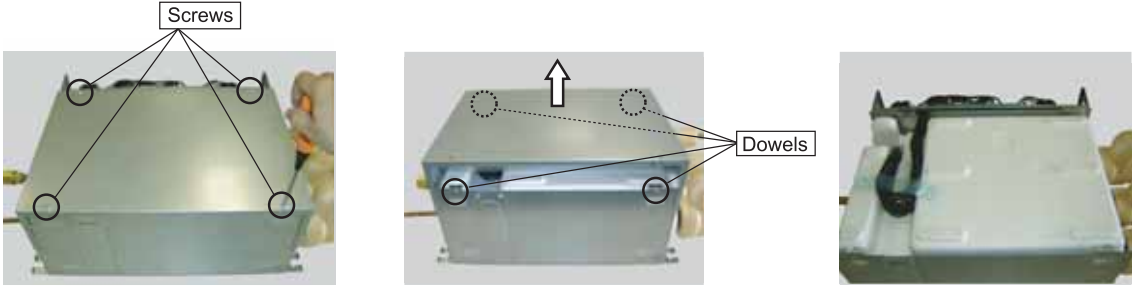

Screws

Remove the mounting screws.

Dowels

Remove the BOTTOM PANEL by sliding upward.

4. INSULATION BOX (BOTTOM) removal

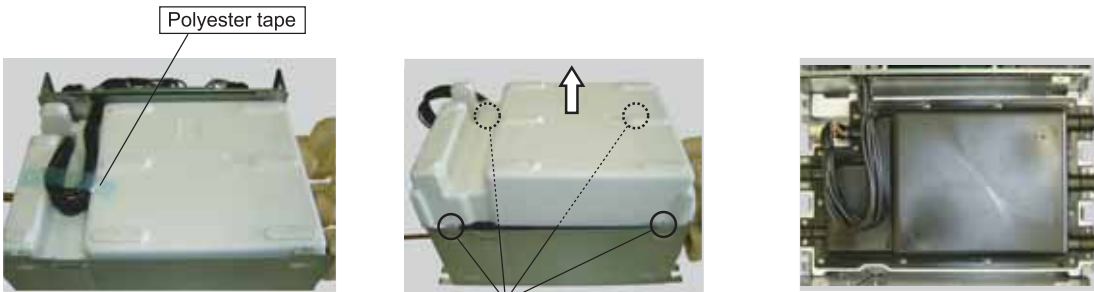

Polyester tape

Remove the polyester tape.

Do not shave down the INSULATION BOX(BOTTOM) in this parts.

Remove the INSULATION BOX(BOTTOM) by sliding upward.

5. CASE (BOTTOM) removal

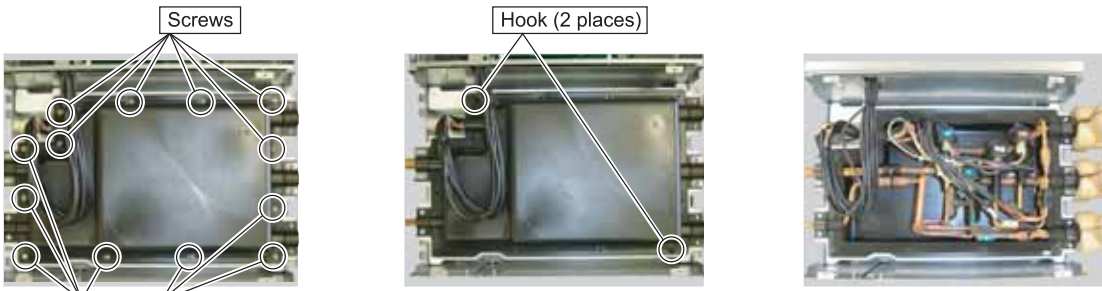

Screws

Screws

Remove the mounting screws. (13 places)

Hook (2 places)

Remove the CASE (BOTTOM).

6. Layout plan in CASE

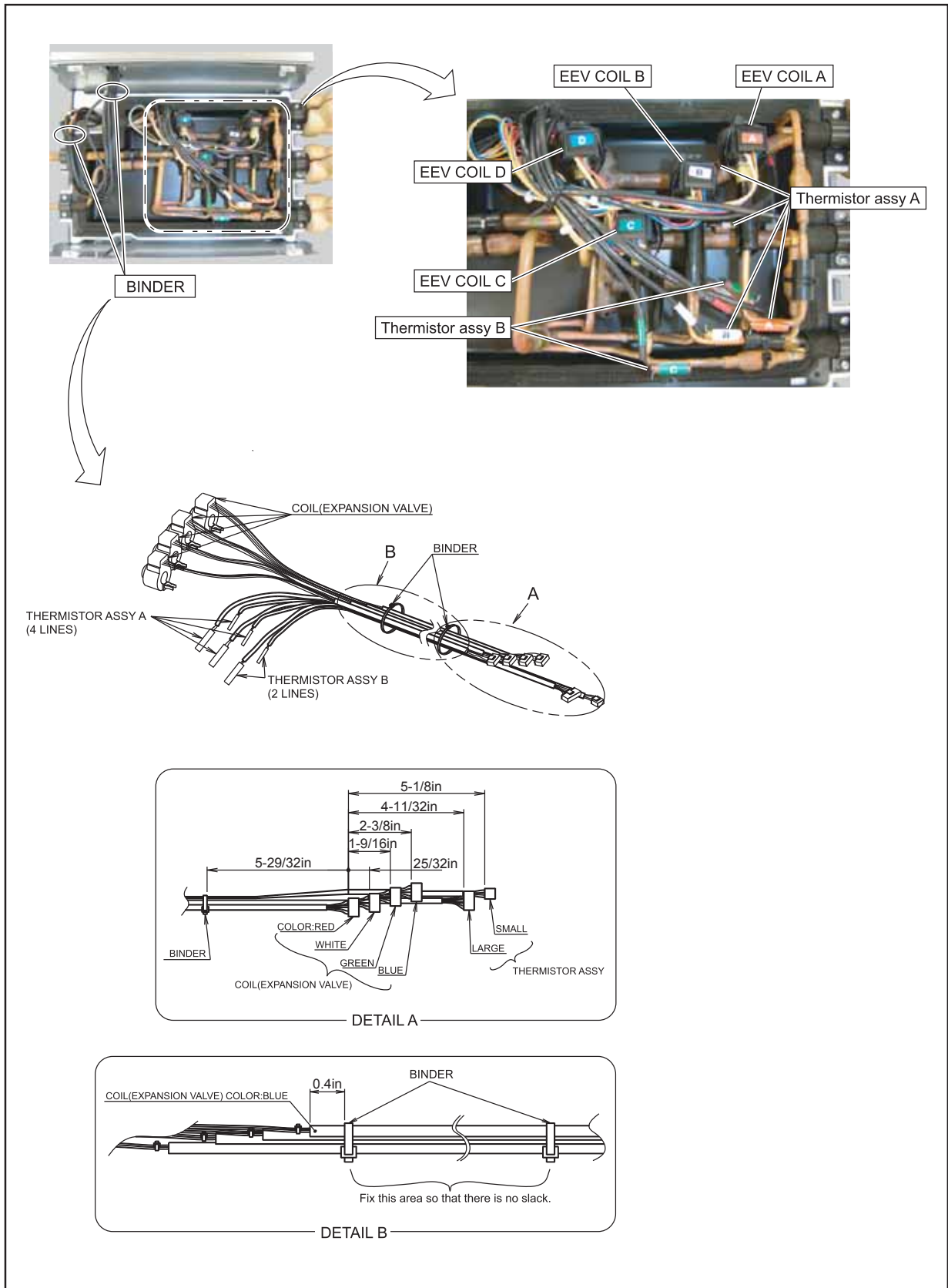

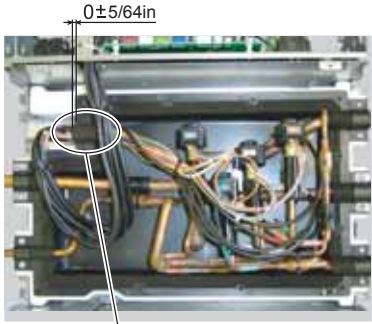

RUBBER (CABLE)

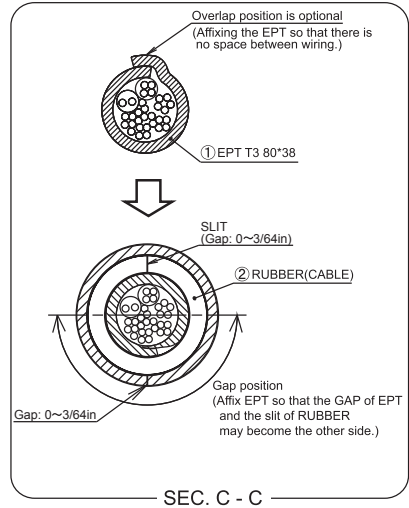
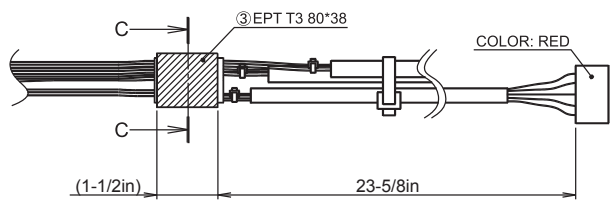
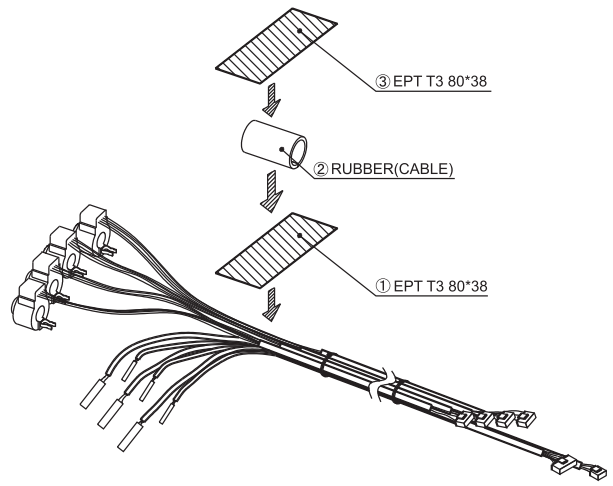

7. THERMISTOR removal

• THERMISTOR (Liquid)



Remove the THERMISTOR SPRING with the THERMISTOR.

• THERMISTOR (Gas)



Remove the THERMISTOR SPRING. Remove the THERMISTOR.

8. EEV COIL removal



Remove the EEV coil by hand.

9. Precautions for exchange of refrigerant-cycle-parts

- (1) During exchange the following parts shall be protected by wet rag and not make the allowable temperature or more.
- (2) Remove the heat insulation when there is the heat insulation near the welding place.
Move and cool it when its detaching is difficult.
- (3) Cool the parts when there are parts where heat might be transmitted besides the replacement part.
- (4) Interrupt the flame with the fire-retardant board when the flame seems to hit the following parts directly.
- (5) Do not allow moisture or debris to get inside refrigerant pipes during work.
- (6) When brazing, be sure to replace the air in the pipe with nitrogen gas to prevent forming oxidization scale.

Part name	Allowable temperature	Precautions in work
EXPANSION VALVE	248°F	Remove the coil before brazing. And install the coil after brazing.
UNION JOINT	212°F	Remove the pressure sensor before brazing. And install the pressure sensor after brazing.